

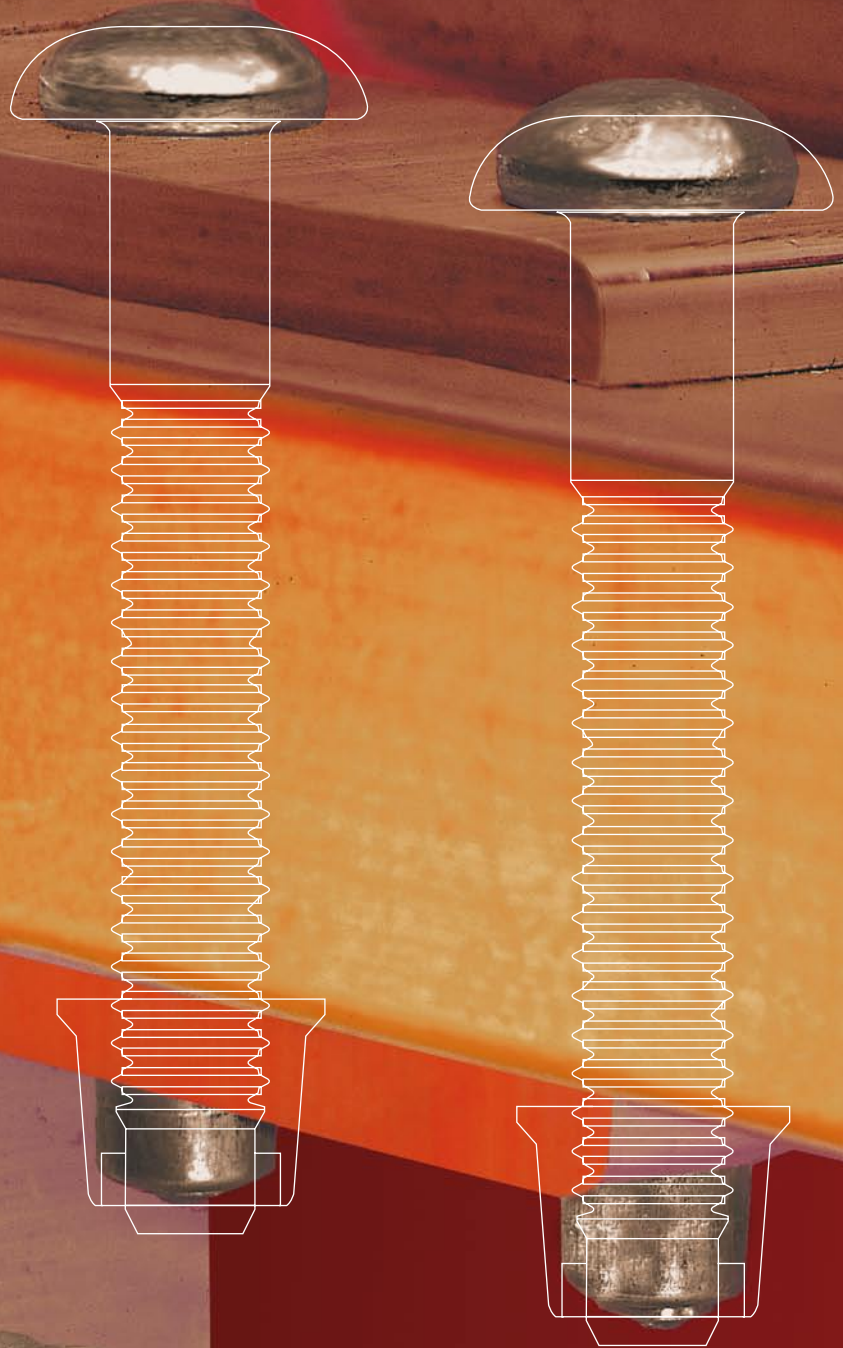

Lockbolt Systems

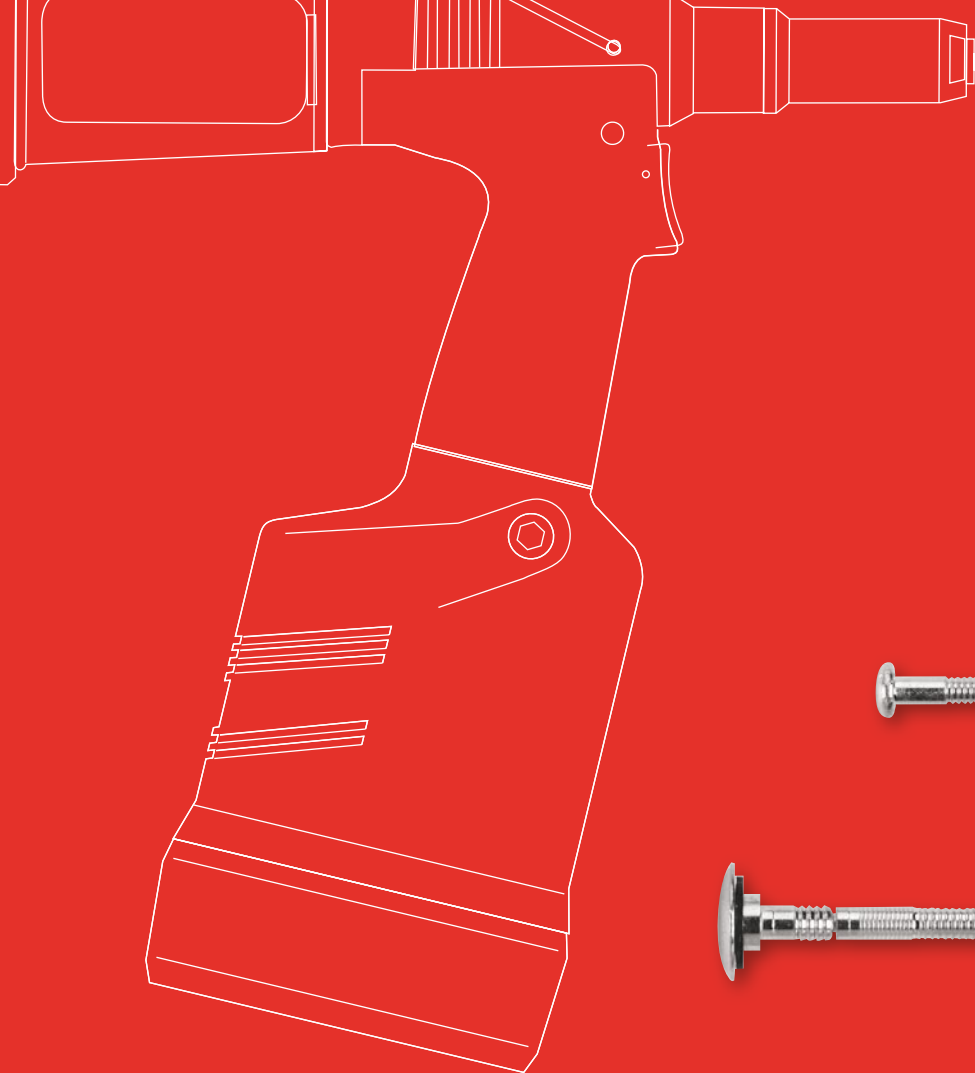



Structural vibration resistant fasteners with high clamp load performance and multi-grip capabilities

Avdel® lockbolts are specified whenever robust and reliable fastening is desired. Our intelligent fastening systems and durable, ergonomic installation tools create an ideal assembly solution in any manufacturing environment.

Avdel® structural lockbolts consist of a separate pin and collar which are mechanically locked during installation. Our fasteners form joints capable of withstanding the toughest applications and environments that traditional rivet and screw joints often cannot provide. They offer exceptional resistance to vibration and material fatigue due to the swaged lock which forms collar material permanently into the circular grooves of the bolt.

Avdel® structural lockbolts can be installed quickly and easily without the need for special training or the skilled labour that's often required for other fastening methods. This simple installation process eliminates negative manufacturing influences including examples of RSI (Repetitive Strain Injury) – thus ensuring safety & quality from the first to the last installation.

Avdel® structural lockbolts are mostly used in the automotive, HGV & transportation markets as well as machinery and equipment manufacturing, heating and ventilation, and metal fabrication and construction.

The Avdel® structural lockbolt range can provide a cost effective solution for any application, often reducing total assembly cost and time as well as inventory.

Together with our customers we develop fastening systems that simplify your production process and improve the quality and functionality of your products. We are not just a provider of fasteners and equipment but a design and development partner helping you to improve assembly and product performance.

Contents Page

Systems Range Overview	Avdel® Structural Lockbolt Systems	4
	Range Overview	5
	Selection Guide	6-7
Avdel® Lockbolt Range	Avdelok®	8-9
	Maxlok®	10
	Avtainer®	11
	Avbolt®	12
Installation Equipment	Installation Tools	13-14
Data Sheets	Avdelok®	15-37
	Avdelok® LD	38-40
	Maxlok®	41-45
	Avtainer®	46-47
	Avbolt®	48-50
	The Range of Avdel® Blind Fastening Systems	51

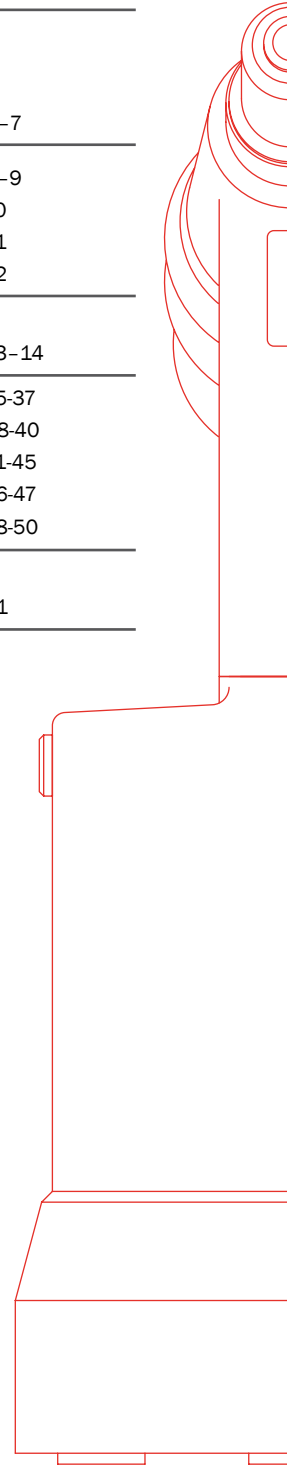
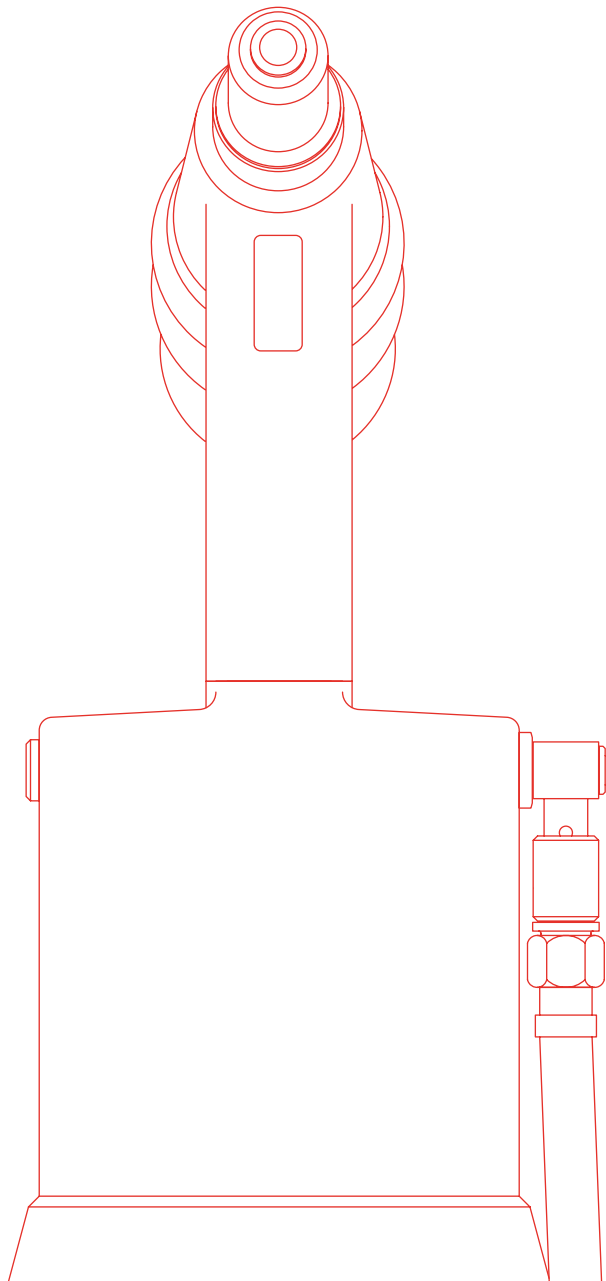
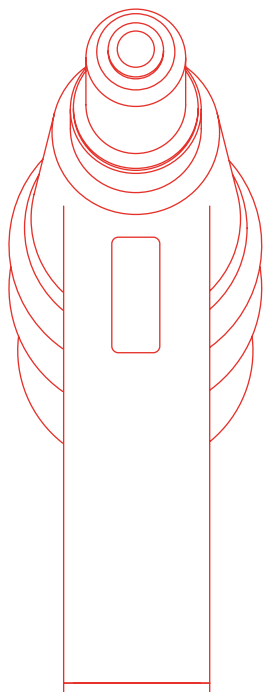

Avdel® Structural Lockbolt Systems

Avdel® lockbolt systems are designed for high strength, secure assembly. Quick and simple to place, durable and long lasting, they are the ideal solution where spot welding is not practical and other methods are costly, time consuming or not possible. Avdel® lockbolt systems have been widely used for many years in demanding engineering industries throughout the world, including vehicle body building, railways, construction and containers.

Benefits of assembly

High speed assembly

Avdel® lockbolts are placed in seconds, to provide a secure, long-lasting joint.

High shear and tensile strength

Avdel® lockbolts have been designed to deliver the high strength performance required in load-bearing, structural applications.

Consistent, high performance

Designed and manufactured to close tolerances, Avdel® lockbolt systems ensure consistently accurate and secure, high strength assembly. Combined with a special purpose tool, Avdel® lockbolts eliminate installation errors or variability of clamp associated with conventional assembly methods.

Robust and rugged tools

Designed for use in demanding engineering environments, these tools have a long and reliable track record. They provide consistently accurate and secure installation within a few seconds.

Excellent vibration resistance





As permanent as a weld, Avdel® lockbolts resist loosening when all other methods fail.

Ease of inspection

A quick and simple visual inspection is sufficient to check that an Avdel® lockbolt has been correctly installed and tampering is immediately obvious. Avdelok®, Maxlok® and Avtainer® lockbolts are TIR approved.



Range overview

Brand	Material	Key features
Avdelok® 	Aluminium Alloy Steel Stainless Steel	High shear strength High controlled clamp
Large diameter Avdelok® LD 	Steel	Exceptional shear and tensile strength Sizes from 12.7 mm (1/2") to 25.4 mm (1")
Maxlok® 	Aluminium Alloy Steel	Wide grip range High shear strength
Avtainer® 	Steel	High shear strength Joins composite panels to metal Leak resistant High speed installation
Avbolt® 	Steel	Use on blind sided applications High tensile and shear strength High grip capability

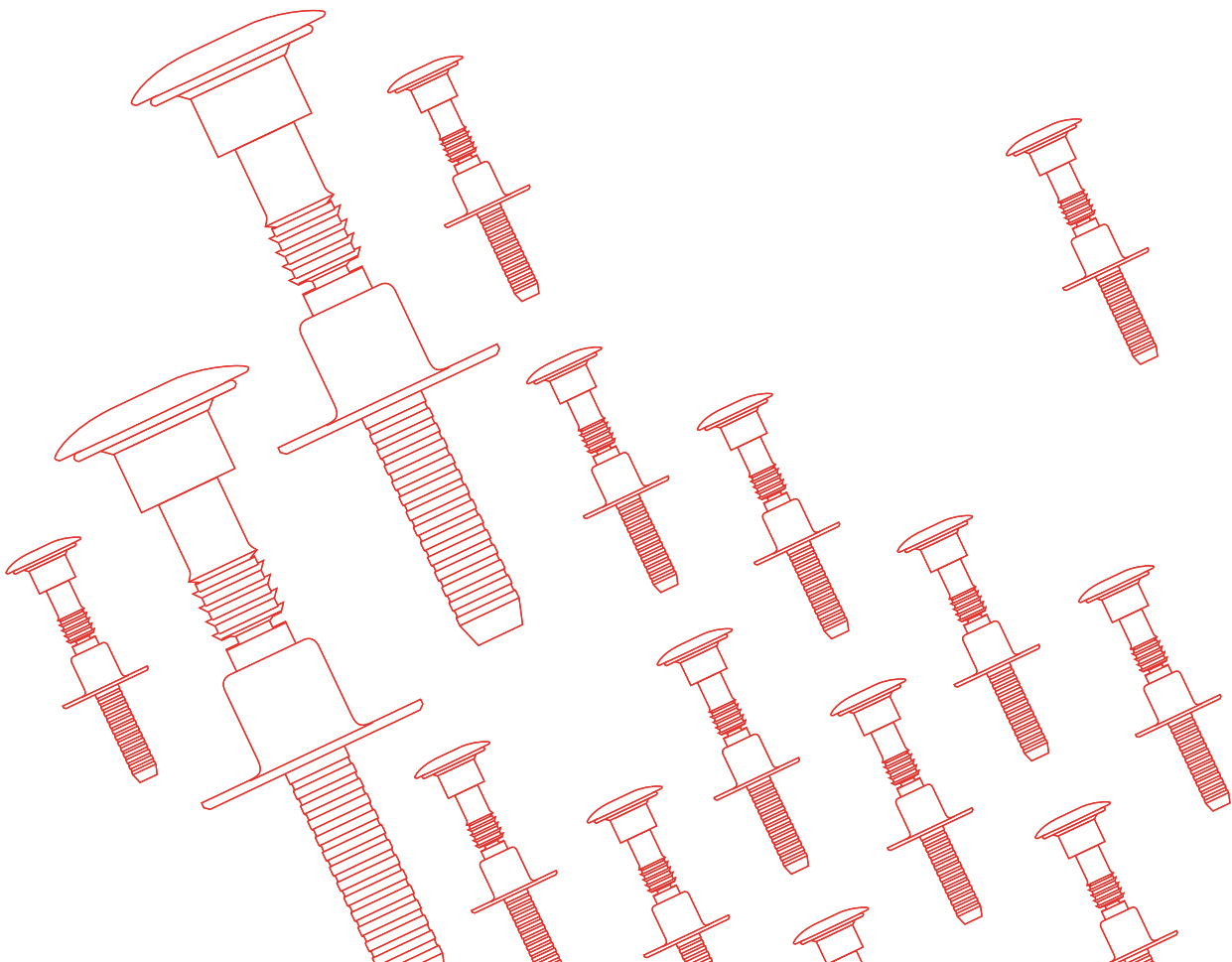

Selecting a Lockbolt Fastener

Selecting an Avdel® structural lockbolt fastener is a simple process. The factors detailed below are designed to help you identify a fastener suitable for your application:

Fastener selection

Accessibility

If there is only access from one side the Avbolt® structural blind fastener is the only choice. Avdelok®, Maxlok® and Avtainer® lockbolts require access from both sides of the component.

Grip range

The fastener should be selected to ensure that the thicknesses of the parent materials fall within the grip range.

Hole size

This is specified on the relevant technical data sheet for the structural fastener. It is important to control the hole size accurately in order to ensure the performance of the fastener.

Corrosion Resistance

Material and plating selection should be based on the level of corrosion resistance required. Corrosion is best reduced by selecting a fastener material which is the same as the parent material(s). Stainless steel fasteners offer the best corrosion resistance.

Important Information

The information on this page should be used in conjunction with the technical data available on our website www.avdel-global.com where you can also find additional information about corrosion, safety and RoHS.

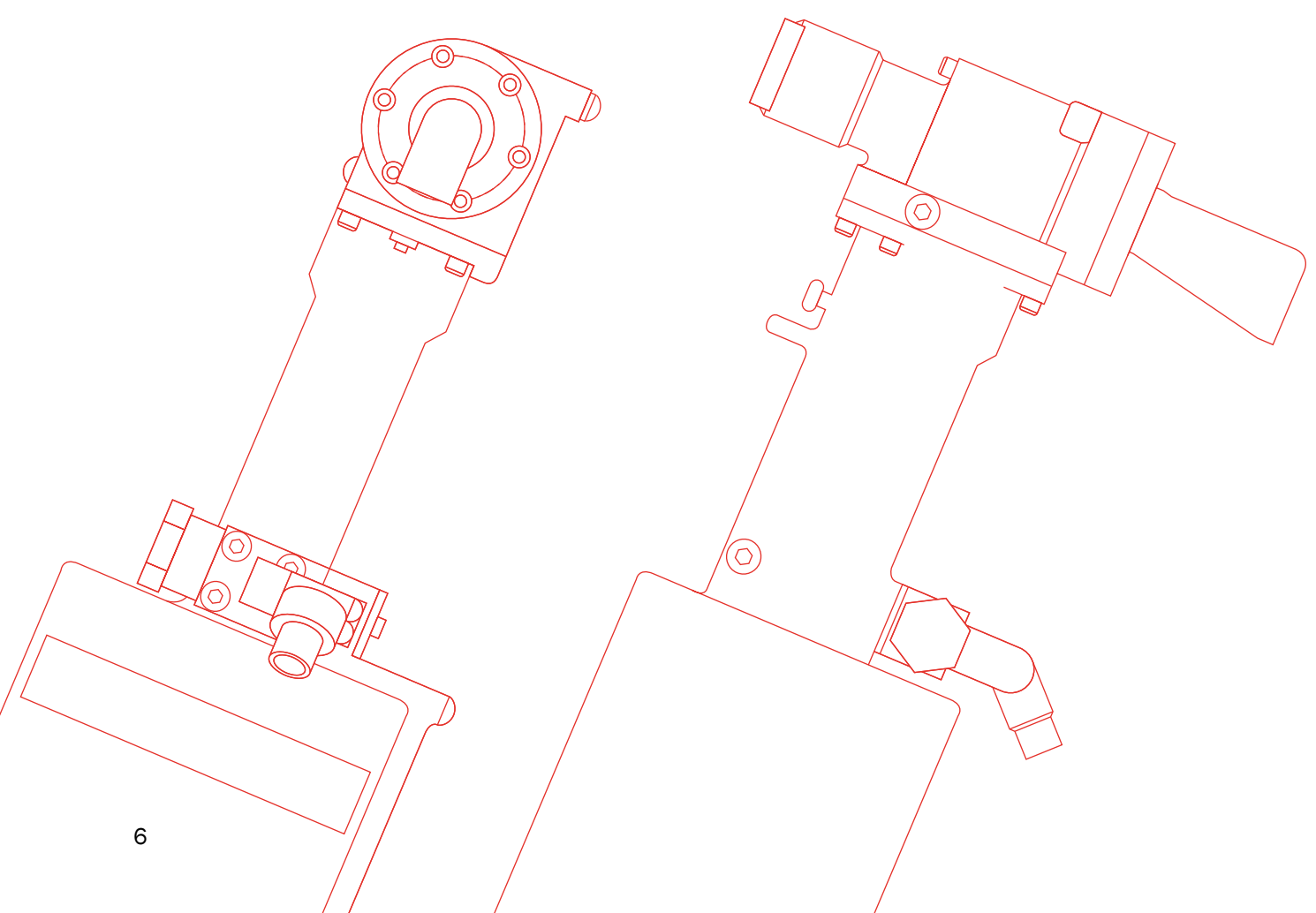

Selection Guide

This table is designed as a guide to help you select the most suitable Avdel® lockbolt for your particular application. Full technical and performance data for each fastener can be found on our website www.avdel-global.com or contact your local Avdel representative.

Product Range	Material Pin & Collar		Headform Pin							Collar			Fastener Size (nom)								Page No.				
	Aluminium	Steel	Brazier head	90° Countersunk	Truss head	Large head	Round head	Mushroom head	Low profile	Full	Half	Flanged	4.8 mm (3/16")	6.4 mm (1/4")	8.0 mm (5/16")	9.6 mm (3/8")	10.0 mm (3/8")	12.7 mm (1/2")	15.9/16 mm (5/8")	19.1 mm (3/4")	22.2 mm (7/8")	25.4 mm (1")	Series No.	Description	Data Sheet
Avdelok®		•	•							•	•	•	•	•	•								2621	8-9	15
		•		•						•	•	•	•	•	•								2622	8-9	18
		•			•					•	•	•	•	•	•								2624	8-9	21
			•	•						•		•	•	•	•								2691	8-9	24
		•		•						•	•	•	•	•	•								2801	8-9	27
		•			•					•	•	•	•	•	•								2802	8-9	30
		•				•				•	•	•	•	•	•								2803	8-9	33
		•					•			•	•	•				•							2804	8-9	36
Avdelok® LD		•					•		•		•						•	•	•	•	•	2861	8-9	38	
Maxlok®		•	•						•			•	•										1901	10	41
		•		•					•			•											1902	10	42
		•						•	•			•	•										1903	10	43
		•				•			•			•	•										1905	10	44
		•		•						•			•	•									1921	10	45
Avtainer®		•						•								•						2311	11	46	
Avbolt®		•														•	•	•					21001	12	48
		•										•	•	•									21021	12	49

Our policy is one of continuous product development and improvement and we reserve the right to change the specification of any product without prior notice.

Avdelok®

High strength, vibration resistant lockbolts with high, controlled clamp.



Key features and benefits

- High shear strength for high strength assembly
- High, controlled clamp provides excellent vibration resistance
- Quick to install across a wide range of applications
- Comprehensive range of special purpose installation tools
- Wide choice of materials, sizes, head forms and collar options to suit a wide variety of applications
- Easy to inspect for tampering
- TIR approved
- Large diameter option from 12.7 mm ($\frac{1}{2}$ ") to 25.4 mm (1") for heavy engineering applications
- Steel Avdelok® pins typically offer comparable values to property class 5.8 threaded products
- Installed Avdelok® LD fasteners provide a minimum shear, tensile and pre-load strength which is equivalent to or exceeds property class 8.8 or ASTM A-325 standards

Specifications

Avdelok®

Sizes:

4.8 mm to 9.6 mm
($\frac{3}{16}$ " to $\frac{3}{8}$ ")

Materials:

Aluminium alloy, steel,
stainless steel

Headforms:

Brazier, countersunk, truss,
large

Collar options:

Full, half, flanged

Avdelok® LD

Sizes:

12.7 mm to 25.4 mm
($\frac{1}{2}$ " to 1")
(28.6 mm/ $\frac{1\frac{1}{8}}$ " optional)

Materials:

Steel

Headforms:

Round, large truss head,
countersunk

Collar options:

Full, flanged

Typical placing sequence

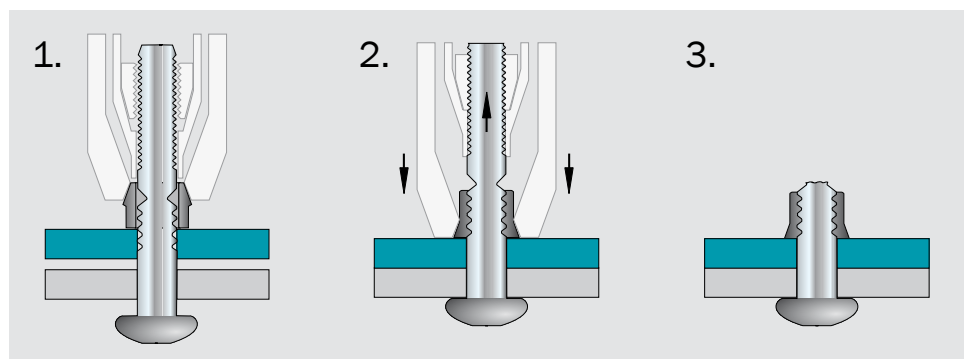

Please visit our website www.avdel-global.com for fastener placing animations and technical data.

Assembly applications

- Commercial vehicles
- Heating systems
- Steel construction
- Bridge building
- Solar panels
- Railway
- Mining

Heating systems

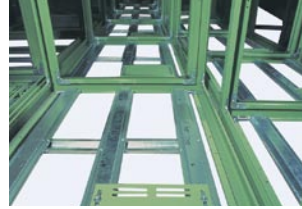

Commercial vehicles

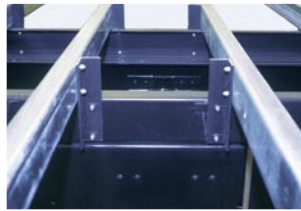

Solar power plants

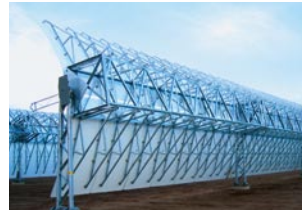

Solar power plants (detail)

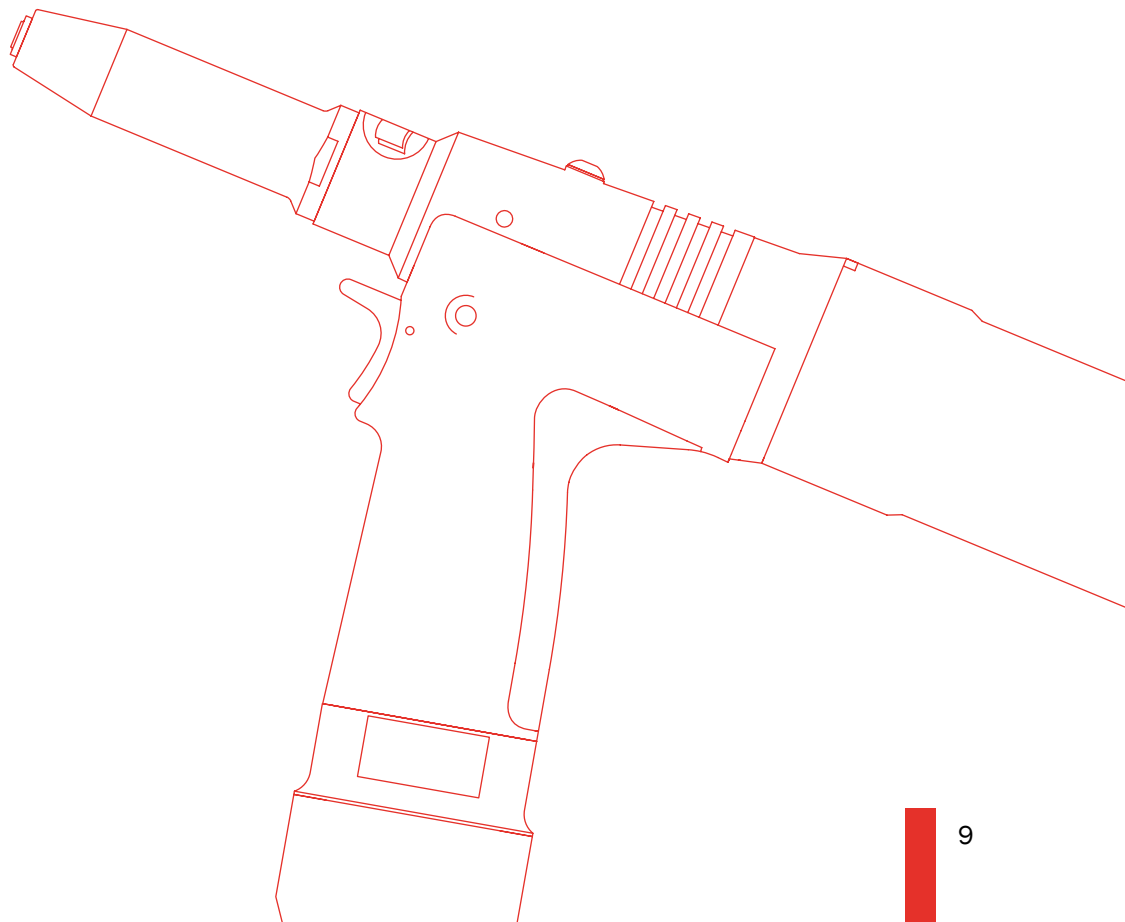

Maxlok®

High strength, vibration resistant lockbolts with multi-grip capability.



Key features and benefits

- Wide grip range reduces inventory, simplifies stock control, and accommodates wide variations in material thickness
- High shear strength for high strength assembly
- High, controlled clamp provides excellent vibration resistance
- Wide range of special purpose installation tools
- Quick to install across a wide range of applications
- Brazier, countersunk, mushroom and truss head forms suit a wide variety of applications
- Easy to inspect tampering
- TIR approved

Specifications

Sizes:

4.8 mm to 6.4 mm
($\frac{3}{16}$ " to $\frac{1}{4}$ ")

Material:

Aluminium alloy, steel

Headforms:

Brazier, countersunk,
mushroom and truss

Collar option:

Flanged

Typical placing sequence

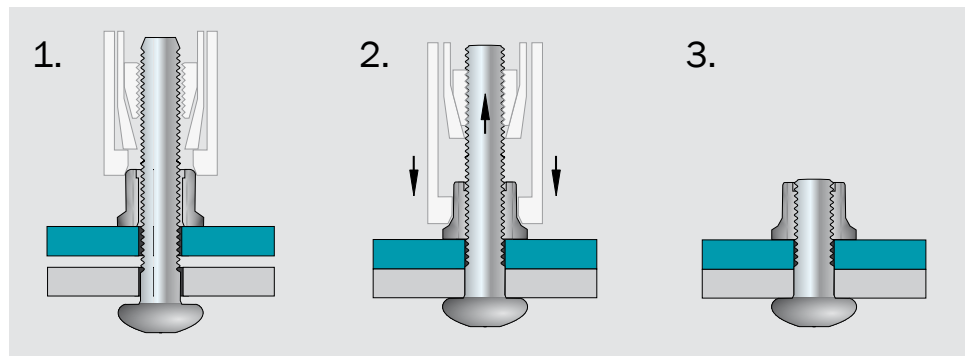

Please visit our website www.avdel-global.com for fastener placing animations and technical data.

Assembly applications

- Commercial vehicles
- Heating and ventilation
- Frame building

Commercial vehicles



Fan bearing arm

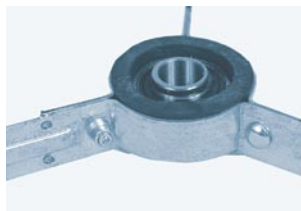

Avtainer[®]

High strength, steel fastener and shell designed for joining composite panels to metal.



Key features and benefits

- Prevents cracking and pull through of composite materials
- Ideal for the assembly of GRP vehicle panels
- High shear strength for high strength assembly
- Underhead Santoprene[®] seal for a water/air tight joint
- Internally locked stem provides a secure, vibration resistant joint
- Smaller shell size available for use against metal surfaces
- Low profile head and shell give a neat appearance
- Optional encapsulated heads to match the surrounding colour
- Quick to install with Genesis[®] power tools
- Easy to inspect for tampering
- TIR approved

Specifications

Sizes:

10.0 mm ($\frac{3}{8}$ ")

Material:

Steel

Headforms:

Low profile

Option:

Encapsulated heads

Typical placing sequence

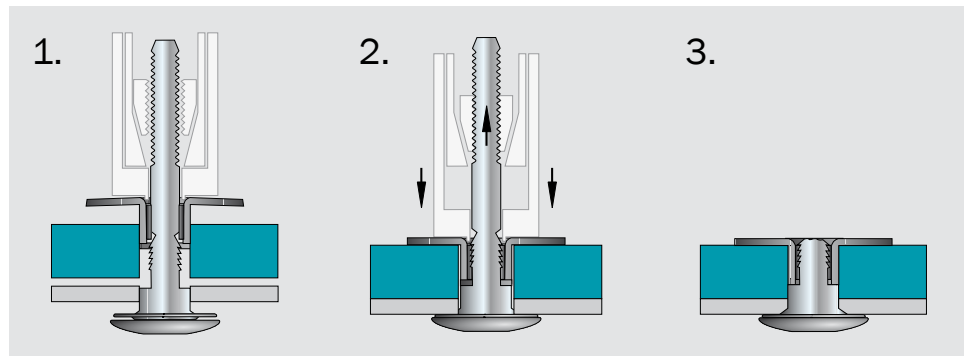

Please visit our website www.avdel-global.com for fastener placing animations and technical data.

Assembly applications

- Commercial vehicles
- Container



Avbolt® Structural Blind Fastener

The Avbolt® structural fastener is a high strength, tamper resistant, blind steel fastener designed for use in heavy-duty structural applications. It offers a high tensile and shear strength normally only possible with non blind lockbolts and combines it with the installation speed of blind products.



Avbolt® 10, 12, 7 and 16 mm ($\frac{3}{8}$ ", $\frac{1}{2}$ " and $\frac{5}{8}$ "):
3 piece design (sleeve, collar, stem)



Avbolt® 4.8, 6.4 and 8.0 mm ($\frac{3}{16}$ ", $\frac{1}{4}$ ", $\frac{5}{16}$ "):
2 piece design (sleeve with collar, stem)

Key features and benefits

- Use on blind sided application
- High tensile and shear strength for heavy-duty applications
- Wide grip capability suits a variety of material thicknesses
- Locking feature creates a vibration resistant joint and prevents loose stems
- Ideal for areas with restricted access
- Fast installation
- High security tamper resistance
- Simple tooling requires only minimum operator skill

Specifications

Sizes:

4.8 mm to 16.0 mm

($\frac{3}{16}$ " to $\frac{5}{8}$ ")

Material:

Steel

Avdel Patent Protected.

Typical placing sequence (3 piece design)

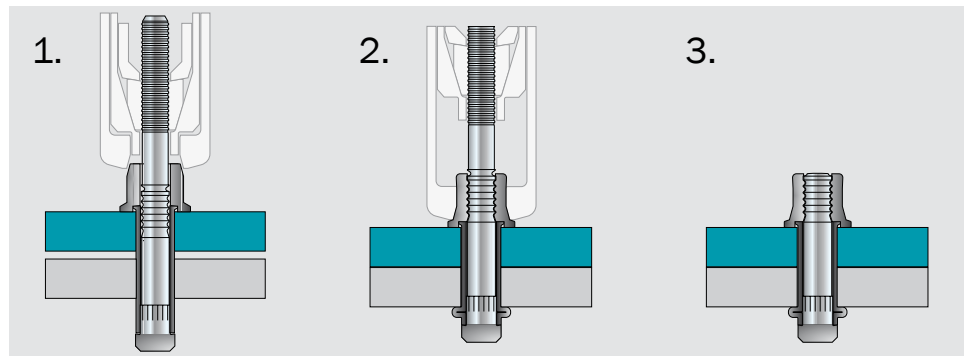

Please visit our website www.avdel-global.com for fastener placing animations and technical data.

Assembly applications

- Automotive
- Construction
- Container
- Renewable energies
- Railway
- Mining
- Security fencing



Installation Tools

Genesis® G2 LB (71255 Model)

Lightweight tool for placing Avdelok® lockbolts \varnothing 4.8 mm and 6.4 mm ($\frac{3}{16}$ " and $\frac{1}{4}$ ") and Maxlok® lockbolts \varnothing 4.8 mm ($\frac{3}{16}$ ") at high speed making it ideal for batch or flow-line assembly.

- Ergonomic and lightweight design reduces operator fatigue
- Reduced setting time and high speed placement increases productivity
- Integral cycle counter helps establish accurate service intervals
- Toughened plastic body and heavy duty rubber base resists cracking when accidentally dropped
- Can be suspended

Genesis® nG3

Lightweight tool for placing Avtainer® lockbolts at high speed.

- Ergonomic and lightweight design reduces operator fatigue
- High placement speed increases productivity
- Integral cycle counter helps establish accurate service intervals
- Toughened plastic body and heavy duty rubber base make it a robust tool and enhance tool life
- Soft touch rubber grip on handle
- Vacuum air supply cut-off on trigger minimizes air consumption
- Fixed stem collector bottle
- Can be suspended

Genesis® nG4

Lightweight tool for placing Avdelok® and Maxlok® lockbolts \varnothing 4.8 mm and 6.4 mm ($\frac{3}{16}$ " and $\frac{1}{4}$ ") as well as Avtainer® lockbolts.

- Ergonomic and lightweight design reduces operator fatigue
- Quick cycle time increases productivity
- Integral cycle counter helps establish accurate service intervals
- Toughened plastic body and heavy duty rubber base make it a robust tool for a long working life
- Soft touch rubber grip on handle
- Vacuum air supply cut-off on trigger minimizes air consumption
- Fixed stem collector bottle
- Can be suspended
- Collar cropper attachment available to remove collars from installed Avdelok® and Maxlok® lockbolts

G2 LB (71255 Model)



nG3



nG4



Installation Tools

722 Model

The hydro-pneumatic 722 tool is designed to place all sizes of Avdelok® lockbolts \varnothing 4.8 mm to 9.6 mm ($\frac{3}{16}$ " to $\frac{3}{8}$ ") as well as Avbolt® fasteners \varnothing 4.8 mm to 8.0 mm ($\frac{3}{16}$ " to $\frac{5}{16}$ ").

- Cast aluminium body designed for heavy duty use over long periods of time, even in the most demanding environments
- Quick and simple operation minimizes operator fatigue and reduces assembly time to a minimum
- Wide choice of nose assemblies to suit access restrictions of the application
- Collar cropper attachment available to remove collars from installed Avdelok® lockbolts

7287 Model

Hydro-pneumatic split tool with a lightweight placing head able to place Avdelok® and Avtainer® lockbolts up to \varnothing 10 mm ($\frac{3}{8}$ "), Avbolt® fasteners up to \varnothing 8 mm ($\frac{5}{16}$ ") and all other lockbolts up to \varnothing 8 mm ($\frac{5}{16}$ ").

- Extended stroke and pull force
- Installation of large fasteners with single pull action for high placement speed
- Short cycle time can increase assembly capacity
- Lightweight placing head reduces operator fatigue
- Remote intensifier mounted on castors for flexible use in the assembly line
- Wide choice of directly interchangeable 722 model nose assemblies to suit the access restrictions of the application
- Can be fitted with a collar cropper to remove installed Avdelok® lockbolts

734 Model

All Avdelok® LD lockbolts from \varnothing 12.7 mm to 28.6 mm ($\frac{1}{2}$ " to $1\frac{1}{8}$ ") can be placed securely in seconds with this range of installation tools. Avdelok® lockbolts \varnothing 9.6 mm ($\frac{3}{8}$ ") and Avbolt® \varnothing 8 mm to 16 mm ($\frac{5}{16}$ " to $\frac{5}{8}$ ") can also be installed.

- Robust and rugged installation tools designed for a long working life in extreme conditions
- Range of hydraulic power units deliver the extreme high pull pressure required for secure, long lasting assembly at high speed
- Choice of placing heads and nose equipment to suit the entire range of large diameter Avdelok® LD lockbolts as well as other lockbolt brands
- Easy-to-change nose equipment and range of hydraulic hoses in different lengths enable the tool to be adapted to suit local assembly requirements
- Mounted on castors for easy mobility
- Available in voltages from 110V to 525V, diesel option customised to specification
- Switches to 'sleep' mode to conserve energy

722



7287



734





English	Français	Deutsch	Italiano	Español
Brazier head	Tête plate	Flachrundkopf	Testa tonda	Cabeza alomada
Pin: Carbon boron steel* Zinc plated Clear trivalent passivated	Tige: Acier* Revêtement zingué Passivation claire trivalente	Bolzen: Stahl* Verzinkt Klar chromatiert, Cr6-frei	Bullone: Acciaio a carbonio* Zincato Passivazione chiara trivalente	Vástago: Acero al carbono* Zincado Pasivado claro trivalente
Collar: Low carbon steel** Zinc plated Clear trivalent passivated	Bague: Acier bas carbone** Revêtement zingué Passivation claire trivalente	Schließring: Stahl** Verzinkt Klar chromatiert, Cr6-frei	Collare: Acciaio a basso tenore di carbonio** Zincato Passivazione chiara trivalente	Collar: Acero bajo en carbono** Zincado Pasivado claro trivalente

*: SAE 10B21 EN 10263-4 23MnB4 **: SAE 1008 EN 10263-2 C8C

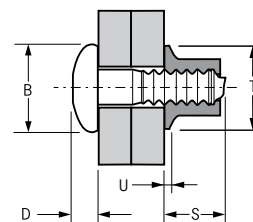
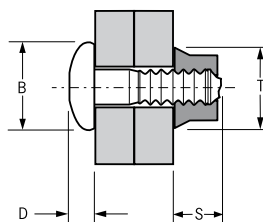
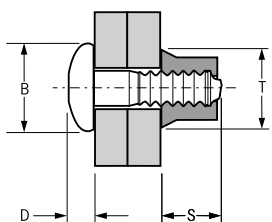
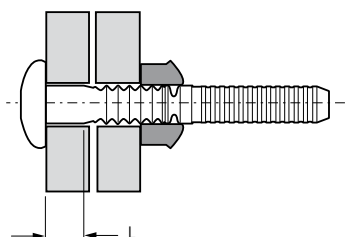

Full Collar
Schließring Standard
Bague Standard
Collare Standard
Collar Estándar

Half Collar
Schließring flach
Bague courte
Collare ribassato
Medio Collar

Flanged Collar
Schließring mit Bund
Bague à embase
Collare flangiato
Collar con Ala

ø	w. Full Collar ²⁾	Š	Ó	Ö	Ú	Ú		Ú		Ú		
						Ú	Ú	Ú	Ú	Ú	Ú	Ú

all dimensions in mm / en millimètre / alle Maße in mm / in millimetri / en milímetros
1), 2), 3) see page 17 / voir page 17 / siehe Seite 17 / vedi pagina 17 / ver Pág. 17

Avdelok® 2621

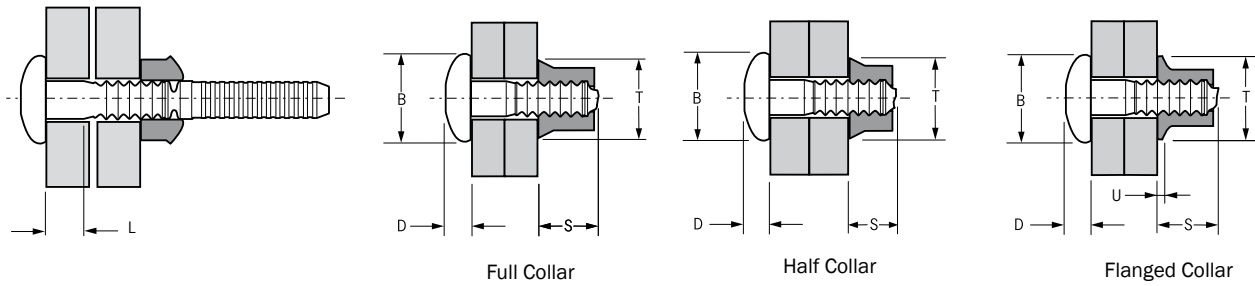

ø	w. Full Collar ²⁾		L	B	D	Part No/ref Pin ¹⁾	Part No/ref Full Collar		Part No/ref Half Collar ²⁾		Part No/ref Flanged Collar ³⁾		
	min.	max.					S max.	T max.	S max.	T max.	S max.	T max.	U ³⁾ nom.
6.4 (1/4")	1.57	4.75	1.57	13.4	4.1	02621-70802	02662-70800	12.2 10.6	02682-70800	13.2 13.1 0.94			
	3.18	6.35	3.18			02621-70803							
	4.75	7.92	4.75			02621-70804							
	6.35	9.53	6.35			02621-70805							
	7.92	11.10	7.92			02621-70806							
	9.53	12.70	9.53			02621-70807							
	11.10	14.27	11.10			02621-70808							
	12.70	15.88	12.70			02621-70809							
	14.27	17.45	14.27			02621-70810							
	15.88	19.05	15.88			02621-70811							
	17.45	20.62	17.45			02621-70812							
	19.05	22.23	19.05			02621-70813							
	20.62	23.80	20.62			02621-70814							
	22.23	25.40	22.23			02621-70815							
23.80	26.97	23.80	02621-70816										
26.97	30.15	26.97	02621-70818										
30.15	33.32	30.15	02621-70820										
8.0 (5/16")	3.18	9.53	3.18	16.7	5.5	02621-71004	02662-71000	15.5 13.3	02682-71000	16.8 16.3 1.22			
	6.35	12.70	6.35			02621-71006							
	9.53	15.88	9.53			02621-71008							
	12.70	19.05	12.70			02621-71010							
	15.88	22.23	15.88			02621-71012							
	19.05	25.40	19.05			02621-71014							
	22.23	28.58	22.23			02621-71016							
	25.40	31.75	25.40			02621-71018							
	28.58	34.93	28.58			02621-71020							
	31.75	38.10	31.75			02621-71022							
	34.93	41.28	34.93			02621-71024							
	38.10	44.45	38.10			02621-71026							
	41.28	47.63	41.28			02621-71028							
	44.45	50.80	44.45			02621-71030							
47.63	53.98	47.63	02621-71032										
9.6 (3/8")	3.18	9.53	.125	20.1	6.7	02621-71204	02662-71200	18.6 15.5	02682-71200	20.0 20.0 1.42			
	6.35	12.70	.250			02621-71206							
	9.53	15.88	.375			02621-71208							
	12.70	19.05	.500			02621-71210							

all dimensions in mm / en millimètre / alle Maße in mm / in millimetri / en milímetros

1), 2), 3) see page 17 / voir page 17 / siehe Seite 17 / vedi pagina 17 / ver Pág. 17

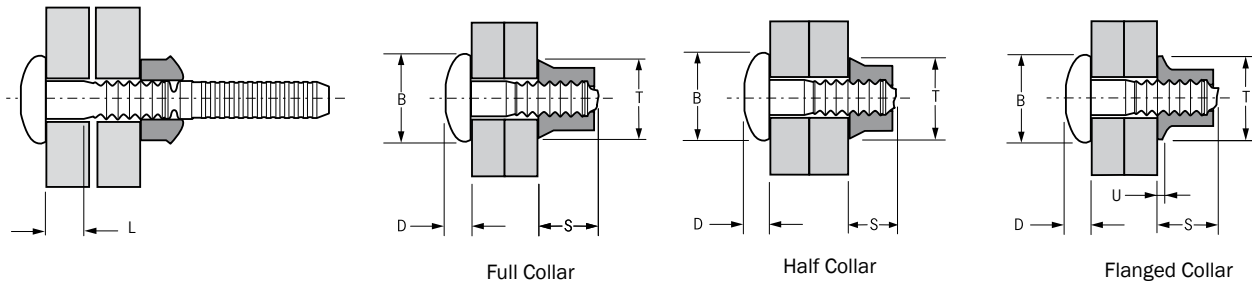

Avdelok® 2621



ø	w. Full Collar ²⁾		L	B	D	Part No/ref Pin ¹⁾	Part No/ref Full Collar		Part No/ref Half Collar ²⁾		Part No/ref Flanged Collar ³⁾		
	nom.	min.					max.	nom.	max.	S max.	T max.	S max.	T max.
9.6 (3/8")	15.88	22.23	15.88	20.1	6.7	02621-71212	18.6	15.5	15.5	15.5	02615-71200 20.0 20.0 1.42		
	19.05	25.40	19.05			02621-71214							
	22.23	28.58	22.23			02621-71216							
	25.40	31.75	25.40			02621-71218							
	28.58	34.93	28.58			02621-71220							
	31.75	38.10	31.75			02621-71222							
	34.93	41.28	34.93			02621-71224							
	38.10	44.45	38.10			02621-71226							
	41.28	47.63	41.28			02621-71228							
	44.45	50.80	44.45			02621-71230							
47.63	53.98	47.63	02621-71232										

all dimensions in mm / en millimètre / alle Maße in mm / in millimetri / en milímetros

- 1) Different grip range pins with different numbers of grooves available. / Tiges avec autres plages de serrage et différent nombre de cannelures sont disponible. / Bolzen mit anderem Klemmbereich und anderer Anzahl von Rillen sind verfügbar. / Sono disponibili bulloni con spessori serrabili differenti con diverso numero di scanalature. / Disponibles pernos con diferente número de anillos según el espesor a remachar.
- 2) Half collars increase the grip range to that of the next longest pin. Maximum grip increases by 1.57 mm (0.062") for 4.8 mm and 6.4 mm fasteners and 3.18 mm (0.125") for 8.0 mm and 9.6 mm fasteners.
 Avec une bague courte, la plage de serrage maximale est équivalente à celle de l'Avdelok de longueur immédiatement supérieure. La plage de serrage augmente de 1.57 mm pour tiges de 4.8 mm et 6.4 mm, et de 3.18 mm pour tiges de 8.0 mm et 9.6 mm.
 Die Verwendung von flachen Schließringen erhöht den Klemmbereich auf den des nächstlängeren Bolzens. Der maximale Klemmbereich erhöht sich um 1,6 mm für ø 4,8 mm und ø 6,4 mm Bolzen und 3,2 mm für ø 8,0 mm und ø 9,6 mm Bolzen.
 Utilizzando i collari ribassati lo spessore serrabile aumenta, ed è uguale a quello massimo del bullone di misura superiore. Il massimo spessore serrabile aumenta di 1.57 mm per i bulloni da 4.8 mm e 6.4 mm e di 3.18 mm per i bulloni da 8.0 mm e 9.6 mm.
 El empleo de medio collar incrementa el máx. espesor a remachar al de la siguiente toma. El máximo espesor a remachar por uso de medio collar es de 1,57 mm para diámetros de 4,8 y 6,4 mm y de 3,18 mm para diámetros de 8 y 9,6 mm.
- 3) Flanged collars are used in applications where the hole on the collar side of the application is oversize or is slotted for alignment purposes. To determine what length of pin is required, add dimension U to the thickness of material being fastened.
 Avec une bague à embase, la plage de serrage est diminuée de la valeur de la cote U.
 Schließringe mit Bund werden in Anwendungen benötigt, wo das Bohrloch auf der Schließringseite übergroß oder länglich ist. Um den richtigen Bolzen zu bestimmen, addieren Sie das Maß U zu der zu verbindenden Materialstärke hinzu.
 Utilizzando i collari flangiati la dimensione „U“ deve essere aggiunta allo spessore da serrare per determinare il tipo di bullone adatto.
 Utilizar collar con ala cuando en la aplicación el taladro está sobredimensionado o es ranurado. Para calcular la referencia de perno necesaria añadir la cota U al espesor de la aplicación.

ø		
nom.	kN ⁴⁾	kN ⁴⁾
4.8 (3/16")	8.63	7.34
6.4 (1/4")	14.73	13.35
8.0 (5/16")	22.38	21.81
9.6 (3/8")	32.08	28.93

- 4) These figures represent minimum fastener shear and tensile strength values with the use of a full collar. When using half collars tension is reduced to approximately 45 %.
 Cette valeurs représentent minimum résistances au cisaillement et à la traction avec l'usage d'une bague standard. Avec l'usage des bagues courtes la résistance à la traction se diminue à env. 45 %.
 Diese Werte repräsentieren Minimum Scher- und Zugfestigkeiten der Verbindung unter Verwendung von Standard-Schließringen. Bei Verwendung von flachen Schließringen reduziert sich die Zugfestigkeit auf ca. 45 %.
 I dati si riferiscono a bulloni installati con collari Standard, utilizzando collari ribassati i valori di trazione diminuiscono del 45 % circa, i valori di taglio rimangono invariati. I dati indicati in tabella sono minimi.
 La figura representa los valores mínimos de resistencia a la cortadura y tracción cuando se utiliza collar estándar. Cuando se utiliza medio collar se reducen aproximadamente en un 45 %.

Steel Avdelok® pins typically offer comparable values to property class 5.8 threaded products. / Les tiges Avdelok® acier offrent des valeurs comparables à celles d'un boulon de classe 5.8. / Avdelok® Bolzen aus Stahl bieten Werte, die normalerweise mit denen eines Gewindeproduktes der Festigkeitsklasse 5.8 gleichzusetzen sind. / I bulloni Avdelok® in acciaio normalmente offrono valori comparabili alla classe di resistenza 5.8 dei prodotti filettati. / Los pernos Avdelok® de acero suelen ofrecer resistencias que equivalen a la calidad 5.8 de los tornillos.

Avdelok® 2622



English	Français	Deutsch	Italiano	Español
90° Countersunk	90° Tête fraisée	90° Senkkopf	90° Testa svasata	90° Cabeza avellanada
Pin: Carbon boron steel* Zinc plated Clear trivalent passivated	Tige: Acier* Revêtement zingué Passivation claire trivalente	Bolzen: Stahl* Verzinkt Klar chromatiert, Cr6-frei	Bullone: Acciaio a carbonio* Zincato Passivazione chiara trivalente	Vástago: Acero al carbono* Zincado Pasivado claro trivalente
Collar: Low carbon steel** Zinc plated Clear trivalent passivated	Bague: Acier bas carbone** Revêtement zingué Passivation claire trivalente	Schließring: Stahl** Verzinkt Klar chromatiert, Cr6-frei	Collare: Acciaio a basso tenore di carbonio** Zincato Passivazione chiara trivalente	Collar: Acero bajo en carbono** Zincado Pasivado claro trivalente

*: SAE 10B21 EN 10263-4 23MnB4 **: SAE 1008 EN 10263-2 C8C

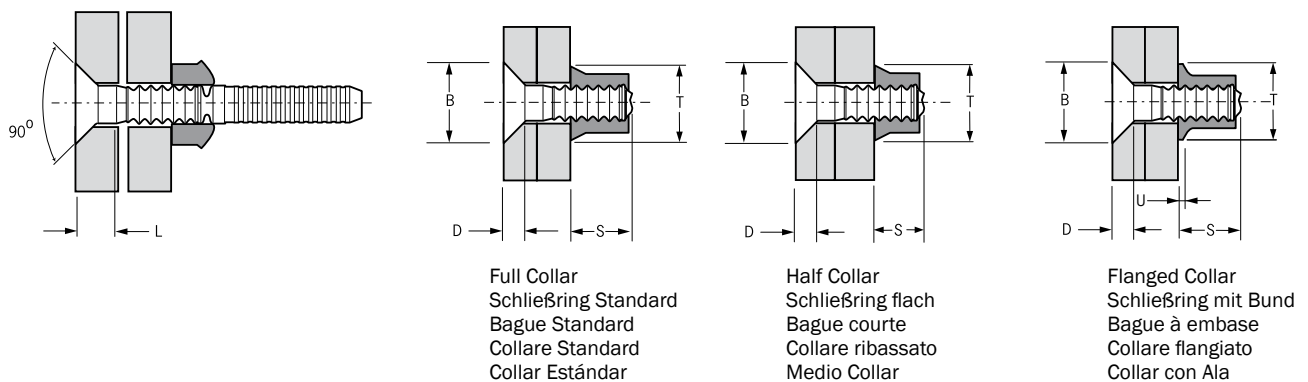

ø	w. Full Collar ²⁾		L	B	D	Part No/ref	Part No/ref		Part No/ref		Part No/ref		
	min.	max.					Full Collar		Half Collar ²⁾		Flanged Collar ³⁾		
nom.			nom.	max.	max.	Pin ¹⁾	S max.	T max.	S max.	T max.	S max.	T max.	U ³⁾ nom.
4.8 (3/16")	3.18	6.35	3.18	8.9	2.2	02622-70603	02662-70600	9.4	8.0	02682-70600	10.2	9.9	0.76
	4.75	7.92	4.75			02622-70604							
	6.35	9.53	6.35			02622-70605							
	7.92	11.10	7.92			02622-70606							
	9.53	12.70	9.53			02622-70607							
	11.10	14.27	11.10			02622-70608							
	12.70	15.88	12.70			02622-70609							
	14.27	17.45	14.27			02622-70610							
	15.88	19.05	15.88			02622-70611							
	17.45	20.62	17.45			02622-70612							
	19.05	22.23	19.05			02622-70613							
	20.62	23.80	20.62			02622-70614							
	22.23	25.40	22.23			02622-70615							
	23.80	26.97	23.80			02622-70616							
25.40	28.58	25.40	02622-70617										
26.97	30.15	26.97	02622-70618										
28.58	31.75	28.58	02622-70619										
30.15	33.32	30.15	02622-70620										

all dimensions in mm / en millimètre / alle Maße in mm / in millimetri / en milímetros
 1), 2), 3) see page 20 / voir page 20 / siehe Seite 20 / vedi pagina 20 / ver Pág. 20

Avdelok® 2622

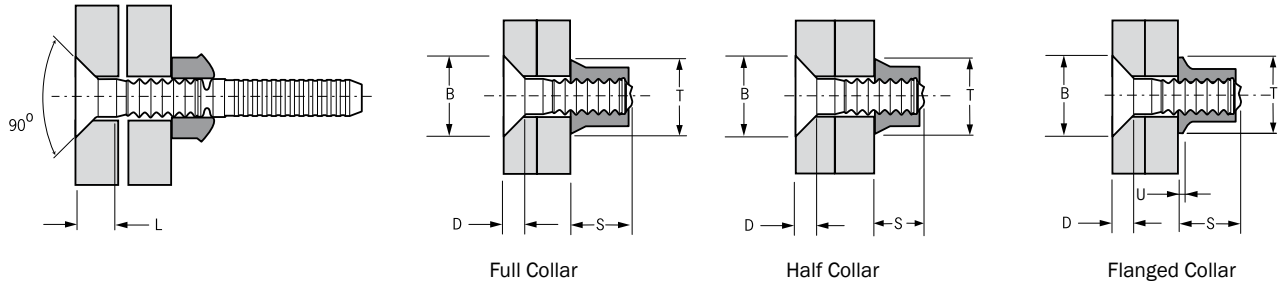

Ø nom.	w. Full Collar ²⁾		L nom.	B max.	D max.	Part No/ref Pin ¹⁾	Part No/ref Full Collar		Part No/ref Half Collar ²⁾		Part No/ref Flanged Collar ³⁾		
	min.	max.					S max.	T max.	S max.	T max.	S max.	T max.	U ³⁾ nom.
6.4 (1/4")	3.18	6.35	3.18	11.9	2.9	02622-70803	02662-70800	12.2	10.6	02682-70800	13.2	13.1	0.94
	4.75	7.92	4.75			02622-70804							
	6.35	9.53	6.35			02622-70805							
	7.92	11.10	7.92			02622-70806							
	9.53	12.70	9.53			02622-70807							
	11.10	14.27	11.10			02622-70808							
	12.70	15.88	12.70			02622-70809							
	14.27	17.45	14.27			02622-70810							
	15.88	19.05	15.88			02622-70811							
	17.45	20.62	17.45			02622-70812							
	19.05	22.23	19.05			02622-70813							
	20.62	23.80	20.62			02622-70814							
	22.23	25.40	22.23			02622-70815							
	23.80	26.97	23.80			02622-70816							
26.97	30.15	26.97	02622-70818										
30.15	33.32	30.15	02622-70820										
8.0 (5/16")	3.18	9.53	3.18	14.8	3.6	02622-71004	02662-71000	15.5	13.3	02682-71000	16.8	16.3	1.22
	6.35	12.70	6.35			02622-71006							
	9.53	15.88	9.53			02622-71008							
	12.70	19.05	12.70			02622-71010							
	15.88	22.23	15.88			02622-71012							
	19.05	25.40	19.05			02622-71014							
	22.23	28.58	22.23			02622-71016							
	25.40	31.75	25.40			02622-71018							
	28.58	34.93	28.58			02622-71020							
	31.75	38.10	31.75			02622-71022							
	34.93	41.28	34.93			02622-71024							
	38.10	44.45	38.10			02622-71026							
	41.28	47.63	41.28			02622-71028							
	44.45	50.80	44.45			02622-71030							
47.63	53.98	47.63	02622-71032										
3/8" (9.6 mm)	6.35	12.70	6.35	17.7	4.4	02622-71206	02662-71200	18.6	15.5	02682-71200	20.0	20.0	1.42
	9.53	15.88	9.53			02622-71208							
	12.70	19.05	12.70			02622-71210							
	15.88	22.23	15.88			02622-71212							
	19.05	25.40	19.05			02622-71214							
	22.23	28.58	22.23			02622-71216							

all dimensions in mm / en millimètre / alle Maße in mm / in millimetri / en milímetros
 1), 2), 3) see page 20 / voir page 20 / siehe Seite 20 / vedi pagina 20 / ver Pág. 20

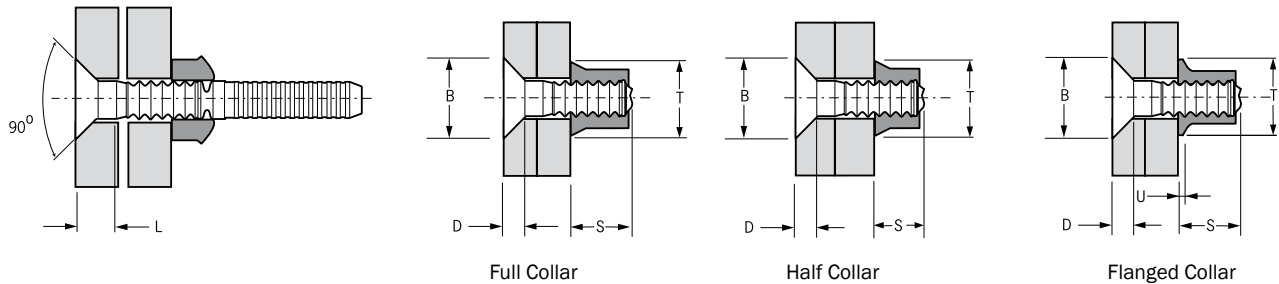

Avdelok® 2622



Ø	w. Full Collar ²⁾		L	B	D	Part No/ref	Part No/ref		Part No/ref				
	min.	max.					Full Collar	Half Collar ²⁾	Flanged Collar ³⁾				
nom.			nom.	max.	max.	Pin ¹⁾	S max.	T max.	S max.	T max.	U ³⁾ nom.		
9.6 (3/8")	25.40	31.75	9.8	25.40	17.7	4.4	02622-71218	02662-71200	02682-71200	02615-71200			
	28.58	34.93		28.58			02622-71220						
	31.75	38.10		31.75			02622-71222						
	34.93	41.28		34.93			02622-71224					18.6 15.5	15.5 15.5
	38.10	44.45		38.10			02622-71226						
	41.28	47.63		41.28			02622-71228						
	44.45	50.80		44.45			02622-71230						
	47.63	53.98		47.63			02622-71232						

all dimensions in mm / en millimètre / alle Maße in mm / in millimetri / en milímetros

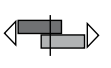
- Different grip range pins with different numbers of grooves available. / Tiges avec autres plages de serrage et différent nombre de cannelures sont disponible./ Bolzen mit anderem Klemmbereich und anderer Anzahl von Rillen sind verfügbar. / Sono disponibili bulloni con spessori serrabili differenti con diverso numero di scanalature. / Disponibles pernos con diferente número de anillos según el espesor a remachar.
- Half collars increase the grip range to that of the next longest pin. Maximum grip increases by 1.57 mm (0.062") for 4.8 mm and 6.4 mm fasteners and 3.18 mm (0.125") for 8.0 mm and 9.6 mm fasteners.
 Avec une bague courte, la plage de serrage maximale est équivalente à celle de l'Avdelok de longueur immédiatement supérieure. La plage de serrage augmente de 1.57 mm pour tiges de 4.8 mm et 6.4 mm, et de 3.18 mm pour tiges de 8.0 mm et 9.6 mm.
 Die Verwendung von flachen Schließringen erhöht den Klemmbereich auf den des nächstlängeren Bolzens. Der maximale Klemmbereich erhöht sich um 1,6 mm für Ø 4,8 mm und Ø 6,4 mm Bolzen und 3,2 mm für Ø 8,0 mm und Ø 9,6 mm Bolzen.
 Utilizzando i collari ribassati lo spessore serrabile aumenta, ed è uguale a quello massimo del bullone di misura superiore. Il massimo spessore serrabile aumenta di 1.57 mm per i bulloni da 4.8 mm e 6.4 mm e di 3.18 mm per i bulloni da 8.0 mm e 9.6 mm.
 El empleo de medio collar incrementa el máx. espesor a remachar al de la siguiente toma. El máximo espesor a remachar por uso de medio collar es de 1,57 mm para diámetros de 4,8 y 6,4 mm y de 3,18 mm para diámetros de 8 y 9,6 mm.
- Flanged collars are used in applications where the hole on the collar side of the application is oversize or is slotted for alignment purposes. To determine what length of pin is required, add dimension U to the thickness of material being fastened.
 Avec une bague à embase, la plage de serrage est diminuée de la valeur de la cote U.
 Schließringe mit Bund werden in Anwendungen benötigt, wo das Bohrloch auf der Schließringseite übergroß oder länglich ist. Um den richtigen Bolzen zu bestimmen, addieren Sie das Maß U zu der zu verbindenden Materialstärke hinzu.
 Utilizzando i collari flangiati la dimensione „U“ deve essere aggiunta allo spessore da serrare per determinare il tipo di bullone adatto.
 Utilizar collar con ala cuando en la aplicación el taladro está sobredimensionado o es ranurado. Para calcular la referencia de perno necesaria añadir la cota U al espesor de la aplicación.

Ø		
nom.	kN ⁴⁾	kN ⁴⁾
4.8 (3/16")	8.63	7.34
6.4 (1/4")	14.73	13.35
8.0 (5/16")	22.38	21.81
9.6 (3/8")	32.08	28.93

- These figures represent minimum fastener shear and tensile strength values with the use of a full collar. When using half collars tension is reduced to approximately 45 %.
 Cette valeurs représentent minimum résistances au cisaillement et à la traction avec l'usage d'une bague standard. Avec l'usage des bagues courtes la résistance à la traction se diminue à env. 45 %.
 Diese Werte repräsentieren Minimum Scher- und Zugfestigkeiten der Verbindung unter Verwendung von Standard-Schließringen. Bei Verwendung von flachen Schließringen reduziert sich die Zugfestigkeit auf ca. 45 %.
 I dati si riferiscono a bulloni installati con collari Standard, utilizzando collari ribassati i valori di trazione diminuiscono del 45 % circa, i valori di taglio rimangono invariati. I dati indicati in tabella sono minimi.
 La figura representa los valores mínimos de resistencia a la cortadura y tracción cuando se utiliza collar estándar. Cuando se utiliza medio collar se reducen aproximadamente en un 45 %.

Steel Avdelok® pins typically offer comparable values to property class 5.8 threaded products. / Les tiges Avdelok® acier offrent des valeurs comparables à celles d'un boulon de classe 5.8. / Avdelok® Bolzen aus Stahl bieten Werte, die normalerweise mit denen eines Gewindeproduktes der Festigkeitsklasse 5.8 gleichzusetzen sind. / I bulloni Avdelok® in acciaio normalmente offrono valori comparabili alla classe di resistenza 5.8 dei prodotti filettati. / Los pernos Avdelok® de acero suelen ofrecer resistencias que equivalen a la calidad 5.8 de los tornillos.

Avdelok® 2624



English	Français	Deutsch	Italiano	Español
Truss head	Tête large	Flachrundkopf groß	Testa larga	Cabeza alomada de perfil bajo
Pin: Carbon boron steel* Zinc plated Clear trivalent passivated	Tige: Acier* Revêtement zingué Passivation claire trivalente	Bolzen: Stahl* Verzinkt Klar chromatiert, Cr6-frei	Bullone: Acciaio a carbonio* Zincato Passivazione chiara trivalente	Vástago: Acero al carbono* Zincado Pasivado claro trivalente
Collar: Low carbon steel** Zinc plated Clear trivalent passivated	Bague: Acier bas carbone** Revêtement zingué Passivation claire trivalente	Schließring: Stahl** Verzinkt Klar chromatiert, Cr6-frei	Collare: Acciaio a basso tenore di carbonio** Zincato Passivazione chiara trivalente	Collar: Acero bajo en carbono** Zincado Pasivado claro trivalente

*: SAE 10B21 EN 10263-4 23MnB4 **: SAE 1008 EN 10263-2 C8C

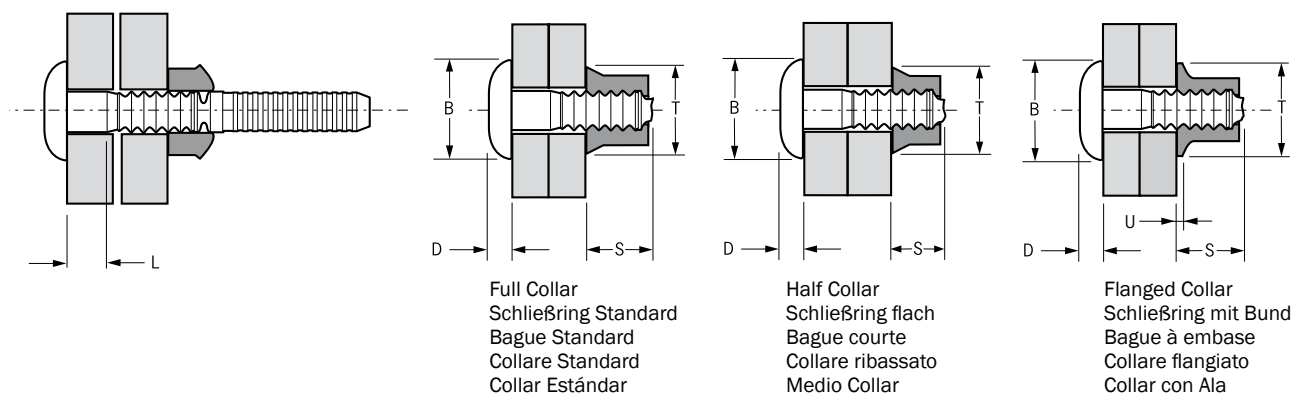

ø	w. Full Collar ²⁾		L	B	D	Part No/ref	Part No/ref		Part No/ref		Part No/ref						
	min.	max.					nom.	max.	max.	Pin ¹⁾	Full Collar		Half Collar ²⁾		Flanged Collar ³⁾		
nom.			nom.	max.	max.		S	T	S	T	S	T	U ³⁾				
							max.	max.	max.	max.	max.	max.	nom.				
4.8 (3/16")	1.57	4.75	5.0	1.57	12.0	2.2	02624-70602	02662-70600	9.4	8.0	02682-70600	7.9	8.0	02615-70600			
	3.18	6.35		3.18			02624-70603								10.2	9.9	0.76
	4.75	7.92		4.75			02624-70604										
	6.35	9.53		6.35			02624-70605										
	7.92	11.10		7.92			02624-70606										
	9.53	12.70		9.53			02624-70607										
	11.10	14.27		11.10			02624-70608										
	12.70	15.88		12.70			02624-70609										
	14.27	17.45		14.27			02624-70610										
	15.88	19.05		15.88			02624-70611										
	17.45	20.62		17.45			02624-70612										
	19.05	22.23		19.05			02624-70613										
	20.62	23.80		20.62			02624-70614										
	22.23	25.40		22.23			02624-70615										
	23.80	26.97		23.80			02624-70616										
	25.40	28.58		25.40			02624-70617										
26.97	30.15	26.97	02624-70618														
28.58	31.75	28.58	02624-70619														
30.15	33.32	30.15	02624-70620														

all dimensions in mm / en millimètre / alle Maße in mm / in millimetri / en milímetros
1), 2), 3) see page 23 / voir page 23 / siehe Seite 23 / vedi pagina 23 / ver Pág. 23

Avdelok® 2624

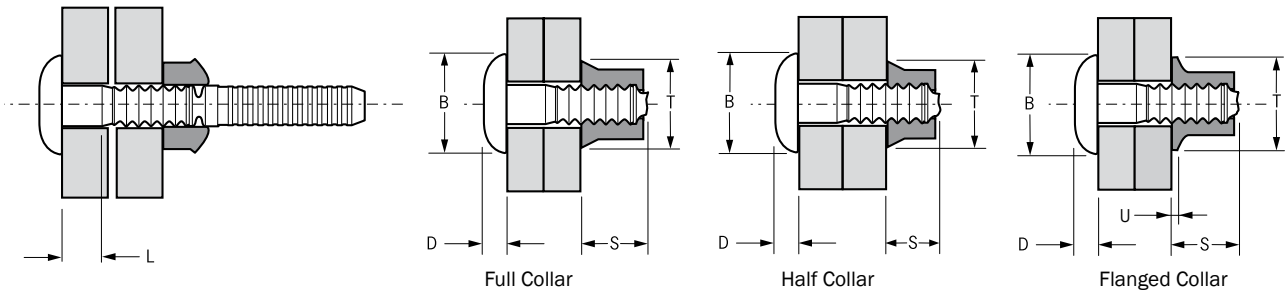

ø	w. Full Collar ²⁾		L	B	D	Part No/ref Pin ¹⁾	Part No/ref Full Collar		Part No/ref Half Collar ²⁾		Part No/ref Flanged Collar ³⁾		
	min.	max.					S max.	T max.	S max.	T max.	S max.	T max.	U ³⁾ nom.
6.4 (1/4")	1.57	4.75	1.57	15.2	2.8	02624-70802	02662-70800	12.2 10.6	02682-70800	13.2 13.1 0.94			
	3.18	6.35	3.18			02624-70803							
	4.75	7.92	4.75			02624-70804							
	6.35	9.53	6.35			02624-70805							
	7.92	11.10	7.92			02624-70806							
	9.53	12.70	9.53			02624-70807							
	11.10	14.27	11.10			02624-70808							
	12.70	15.88	12.70			02624-70809							
	14.27	17.45	14.27			02624-70810							
	15.88	19.05	15.88			02624-70811							
	17.45	20.62	17.45			02624-70812							
	19.05	22.23	19.05			02624-70813							
	20.62	23.80	20.62			02624-70814							
	22.23	25.40	22.23			02624-70815							
	23.80	26.97	23.80			02624-70816							
26.97	30.15	26.97	02624-70818										
30.15	33.32	30.15	02624-70820										
8.0 (5/16")	3.18	9.53	3.18	19.9	3.6	02624-71004	02662-71000	15.5 13.3	02682-71000	16.8 16.3 1.22			
	6.35	12.70	6.35			02624-71006							
	9.53	15.88	9.53			02624-71008							
	12.70	19.05	12.70			02624-71010							
	15.88	22.23	15.88			02624-71012							
	19.05	25.40	19.05			02624-71014							
	22.23	28.58	22.23			02624-71016							
	25.40	31.75	25.40			02624-71018							
	28.58	34.93	28.58			02624-71020							
	31.75	38.10	31.75			02624-71022							
	34.93	41.28	34.93			02624-71024							
	38.10	44.45	38.10			02624-71026							
	41.28	47.63	41.28			02624-71028							
	44.45	50.80	44.45			02624-71030							
	47.63	53.98	47.63			02624-71032							
9.6 (3/8")	3.18	9.53	3.18	23.5	4.1	02624-71204	02662-71200	18.6 15.5	02682-71200	20.0 20.0 1.42			
	6.35	12.70	6.35			02624-71206							
	9.53	15.88	9.53			02624-71208							
	12.70	19.05	12.70			02624-71210							
	15.88	22.23	15.88			02624-71212							

all dimensions in mm / en millimètre / alle Maße in mm / in millimetri / en milímetros
 1), 2), 3) see page 23 / voir page 23 / siehe Seite 23 / vedi pagina 23 / ver Pág. 23

Avdelok® 2624

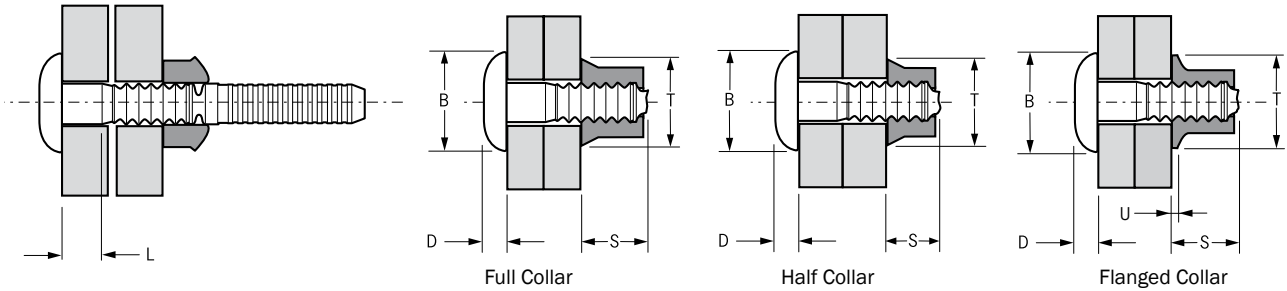

ø	w. Full Collar ²⁾		L	B	D	Part No/ref	Part No/ref		Part No/ref				
	min.	max.					Full Collar	Half Collar ²⁾	Flanged Collar ³⁾				
nom.			nom.	max.	max.	Pin ¹⁾	S max.	T max.	S max.	T max.	S max.	T max.	U ³⁾ nom.
9.6 (3/8")	19.05	25.40	9.8	19.05	23.5	4.1	02624-71214	02662-71200	02682-71200	02615-71200			
	22.23	28.58		22.23			02624-71216						
	25.40	31.75		25.40			02624-71218						
	28.58	34.93		28.58			02624-71220						
	31.75	38.10		31.75			02624-71222						
	34.93	41.28		34.93			02624-71224						
	38.10	44.45		38.10			02624-71226						
	41.28	47.63		41.28			02624-71228						
	44.45	50.80		44.45			02624-71230						
	47.63	53.98		47.63			02624-71232						

all dimensions in mm / en millimètre / alle Maße in mm / in millimetri / en milímetros

1) Different grip range pins with different numbers of grooves available. / Tiges avec autres plages de serrage et différent nombre de cannelures sont disponible. / Bolzen mit anderem Klemmbereich und anderer Anzahl von Rillen sind verfügbar. / Sono disponibili bulloni con spessori serrabili differenti con diverso numero di scanalature. / Disponibles pernos con diferente número de anillos según el espesor a remachar.

2) Half collars increase the grip range to that of the next longest pin. Maximum grip increases by 1.57 mm (0.062") for 4.8 mm and 6.4 mm fasteners and 3.18 mm (0.125") for 8.0 mm and 9.6 mm fasteners.

Avec une bague courte, la plage de serrage maximale est équivalente à celle de l'Avdelok de longueur immédiatement supérieure. La plage de serrage augmente de 1.57 mm pour tiges de 4.8 mm et 6.4 mm, et de 3.18 mm pour tiges de 8.0 mm et 9.6 mm.

Die Verwendung von flachen Schließringen erhöht den Klemmbereich auf den des nächstlängeren Bolzens. Der maximale Klemmbereich erhöht sich um 1,6 mm für ø 4,8 mm und ø 6,4 mm Bolzen und 3,2 mm für ø 8,0 mm und ø 9,6 mm Bolzen.

Utilizzando i collari ribassati lo spessore serrabile aumenta, ed è uguale a quello massimo del bullone di misura superiore. Il massimo spessore serrabile aumenta di 1,57 mm per i bulloni da 4,8 mm e 6,4 mm e di 3,18 mm per i bulloni da 8,0 mm e 9,6 mm.

El empleo de medio collar incrementa el máx. espesor a remachar por uso de medio collar es de 1,57 mm para diámetros de 4,8 y 6,4 mm y de 3,18 mm para diámetros de 8 y 9,6 mm.

3) Flanged collars are used in applications where the hole on the collar side of the application is oversize or is slotted for alignment purposes. To determine what length of pin is required, add dimension U to the thickness of material being fastened.

Avec une bague à embase, la plage de serrage est diminuée de la valeur de la cote U.

Schließringe mit Bund werden in Anwendungen benötigt, wo das Bohrloch auf der Schließringseite übergroß oder länglich ist. Um den richtigen Bolzen zu bestimmen, addieren Sie das Maß U zu der zu verbindenden Materialstärke hinzu.

Utilizzando i collari flangiati la dimensione „U“ deve essere aggiunta allo spessore da serrare per determinare il tipo di bullone adatto.

Utilizar collar con ala cuando en la aplicación el taladro está sobredimensionado o es ranurado. Para calcular la referencia de perno necesaria añadir la cota U al espesor de la aplicación.

ø		
nom.	kN ⁴⁾	kN ⁴⁾
4.8 (3/16")	8.63	7.34
6.4 (1/4")	14.73	13.35
8.0 (5/16")	22.38	21.81
9.6 (3/8")	32.08	28.93

4) These figures represent minimum fastener shear and tensile strength values with the use of a full collar. When using half collars tension is reduced to approximately 45 %.

Cette valeurs représentent minimum résistances au cisaillement et à la traction avec l'usage d'une bague standard. Avec l'usage des bagues courtes la résistance à la traction se diminue à env. 45 %.

Diese Werte repräsentieren Minimum Scher- und Zugfestigkeiten der Verbindung unter Verwendung von Standard-Schließringen. Bei Verwendung von flachen Schließringen reduziert sich die Zugfestigkeit auf ca. 45 %.

I dati si riferiscono a bulloni installati con collari Standard, utilizzando collari ribassati i valori di trazione diminuiscono del 45 % circa, i valori di taglio rimangono invariati. I dati indicati in tabella sono minimi.

La figura representa los valores mínimos de resistencia a la cortadura y tracción cuando se utiliza collar estándar. Cuando se utiliza medio collar se reducen aproximadamente en un 45 %.

Steel Avdelok® pins typically offer comparable values to property class 5.8 threaded products. / Les tiges Avdelok® acier offrent des valeurs comparables à celles d'un boulon de classe 5.8. / Avdelok® Bolzen aus Stahl bieten Werte, die normalerweise mit denen eines Gewindeproduktes der Festigkeitsklasse 5.8 gleichzusetzen sind. / I bulloni Avdelok® in acciaio normalmente offrono valori comparabili alla classe di resistenza 5.8 dei prodotti filettati. / Los pernos Avdelok® de acero suelen ofrecer resistencias que equivalen a la calidad 5.8 de los tornillos.

Avdelok® 2691



English	Français	Deutsch	Italiano	Español
Brazier head	Tête plate	Flachrundkopf	Testa tonda	Cabeza alomada
Pin: Stainless steel* natural	Tige: Inox* Brut	Bolzen: Edelstahl* Blank	Bullone: Acciaio inox * Nessuna finitura	Vástago: Acero inoxidable* Natural
Collar: Stainless steel** Zinc plated Clear trivalent passivated	Bague: Inox** Revêtement zingué Passivation claire trivalente	Schließring: Edelstahl** Verzinkt Klar chromatiert, Cr6-frei	Collare: Acciaio inox** Zincato Passivazione chiara trivalente	Collar: Acero inoxidable** Zincado Pasivado claro trivalente

*: AISI 304Cu, EN 10263-5, X3CrNiCu18-9-4 **: AISI 430, EN 10263-5 X6Cr17

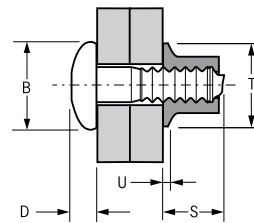
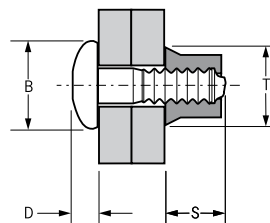
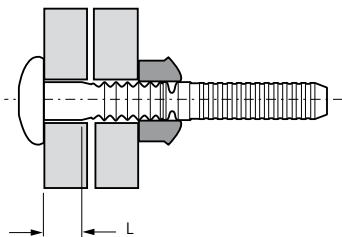

Full Collar
Schließring Standard
Bague Standard
Collare Standard
Collar Estándar

Flanged Collar
Schließring mit Bund
Bague à embase
Collare flangiato
Collar con Ala

Ø nom.	w. Full Collar		L nom.	B max.	D max.	Part No/ref Pin ¹⁾	Part No/ref Full Collar		Part No/ref Flanged Collar ²⁾			
	min.	max.					S max.	T max.	S max.	T max.	U ²⁾ nom.	
4.8 (3/16")	1.57	4.75	1.57	10.0	3.4	02691-00602	02605-70600	9.4	8.0	02648-70600		
	3.18	6.35	3.18			02691-00603						
	4.75	7.92	4.75			02691-00604						
	6.35	9.53	6.35			02691-00605						
	7.92	11.10	7.92			02691-00606						
	9.53	12.70	9.53			02691-00607						
	11.10	14.27	11.10			02691-00608						
	12.70	15.88	12.70			02691-00609						
	14.27	17.45	14.27			02691-00610						
	15.88	19.05	15.88			02691-00611						
	17.45	20.62	17.45			02691-00612						
	19.05	22.23	19.05			02691-00613						
	20.62	23.80	20.62			02691-00614						
	22.23	25.40	22.23			02691-00615						
	23.80	26.97	23.80			02691-00616						
	25.40	28.58	25.40			02691-00617						
	26.97	30.15	26.97			02691-00618						
28.58	31.75	28.58	02691-00619									
30.15	33.32	30.15	02691-00620									

all dimensions in mm / en millimètre / alle Maße in mm / in millimetri / en milímetros

1) & 2) see page 26 / voir page 26 / siehe Seite 26 / vedi pagina 26 / ver Pág. 26

Avdelok® 2691

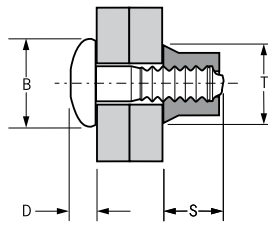
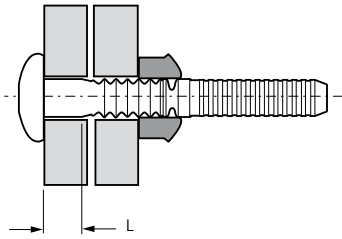

Full Collar

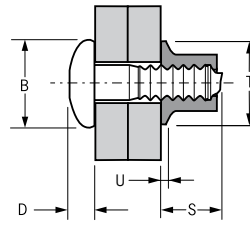

Flanged Collar

ø nom.	w. Full Collar		L nom.	B max.	D max.	Part No/ref Pin ¹⁾	Part No/ref Full Collar		Part No/ref Flanged Collar ²⁾				
	min.	max.					S max.	T max.	S max.	T max.	U ²⁾ nom.		
6.4 (1/4")	1.57	4.75	1.57	13.4	4.1	02691-00802	02605-70800	12.2	10.6	02648-70800	13.2	13.1	0.94
	3.18	6.35	3.18			02691-00803							
	4.75	7.92	4.75			02691-00804							
	6.35	9.53	6.35			02691-00805							
	7.92	11.10	7.92			02691-00806							
	9.53	12.70	9.53			02691-00807							
	11.10	14.27	11.10			02691-00808							
	12.70	15.88	12.70			02691-00809							
	14.27	17.45	14.27			02691-00810							
	15.88	19.05	15.88			02691-00811							
	17.45	20.62	17.45			02691-00812							
	19.05	22.23	19.05			02691-00813							
	20.62	23.80	20.62			02691-00814							
	22.23	25.40	22.23			02691-00815							
	23.80	26.97	23.80			02691-00816							
	26.97	30.15	26.97			02691-00818							
30.15	33.32	30.15	02691-00820										
8.0 (5/16")	3.18	9.53	3.18	16.7	5.5	02691-01004	02605-71000	15.5	13.3	N/A			
	6.35	12.70	6.35			02691-01006							
	9.53	15.88	9.53			02691-01008							
	12.70	19.05	12.70			02691-01010							
	15.88	22.23	15.88			02691-01012							
	19.05	25.40	19.05			02691-01014							
	22.23	28.58	22.23			02691-01016							
	25.40	31.75	25.40			02691-01018							
	28.58	34.93	28.58			02691-01020							
	31.75	38.10	31.75			02691-01022							
	34.93	41.28	34.93			02691-01024							
	38.10	44.45	38.10			02691-01026							
	41.28	47.63	41.28			02691-01028							
	44.45	50.80	44.45			02691-01030							
	47.63	53.98	47.63			02691-01032							

all dimensions in mm / en millimètre / alle Maße in mm / in millimetri / en milímetros

1) & 2) see page 26 / voir page 26 / siehe Seite 26 / vedi pagina 26 / ver Pág. 26

Avdelok® 2691

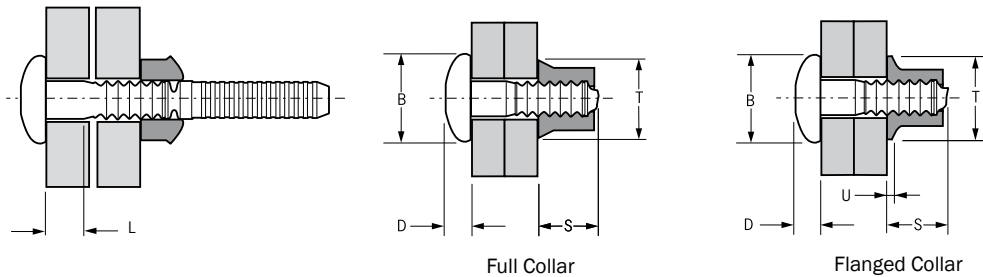

ø nom.	w. Full Collar		L nom.	B max.	D max.	Part No/ref Pin ¹⁾	Part No/ref Full Collar		Part No/ref Flanged Collar ²⁾		
	min.	max.					S max.	T max.	S max.	T max.	U ²⁾ nom.
9.6 (3/8")	3.18	9.53	3.18	20.0	6.7	02691-01204	02605-71200	18.6	15.5	N/A	
	6.35	12.70	6.35			02691-01206					
	9.53	15.88	9.53			02691-01208					
	12.70	19.05	12.70			02691-01210					
	15.88	22.23	15.88			02691-01212					
	19.05	25.40	19.05			02691-01214					
	22.23	28.58	22.23			02691-01216					
	25.40	31.75	25.40			02691-01218					
	28.58	34.93	28.58			02691-01220					
	31.75	38.10	31.75			02691-01222					
	34.93	41.28	34.93			02691-01224					
	38.10	44.45	38.10			02691-01226					
	41.28	47.63	41.28			02691-01228					
	44.45	50.80	44.45			02691-01230					
	47.63	53.98	47.63			02691-01232					

all dimensions in mm / en millimètre / alle Maße in mm / in millimetri / en milímetros

1) Different grip range pins with different numbers of grooves are available

Tiges avec autres plages de serrage et différent nombre de cannelures sont disponible

Bolzen mit anderem Klemmbereich und anderer Anzahl von Rillen sind verfügbar

Sono disponibili bulloni con spessori serrabili differenti con diverso numero di scanalature

Disponibles pernos con diferente número de anillos según el espesor a remachar



2) Flanged collars are used in applications where the hole on the collar side of the application is oversize or is slotted for alignment purposes. To determine what length of pin is required, add dimension U to the thickness of material being fastened.

Avec une bague à embase, la plage de serrage est diminuée de la valeur de la cote U.

Schließringe mit Bund werden in Anwendungen benötigt, wo das Bohrloch auf der Schließringseite übergroß oder länglich ist. Um den richtigen Bolzen zu bestimmen, addieren Sie das Maß U zu der zu verbindenden Materialstärke hinzu.

Utilizzando i collari flangiati la dimensione „U“ deve essere aggiunta allo spessore da serrare per determinare il tipo di bullone adatto.

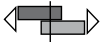
Utilizar collar con ala cuando en la aplicación el taladro está sobredimensionado o es ranurado. Para calcular la referencia de perno necesaria añadir la cota U al espesor de la aplicación.

ø nom.	 kN ³⁾	 kN ³⁾
4.8 (3/16")	7.79	9.26
6.4 (1/4")	14.55	17.71
8.0 (5/16")	22.24	29.80
9.6 (3/8")	31.58	37.81

3) These figures represent minimum fastener shear and tensile strength values with the use of a full collar.

Cette valeurs représentent minimum résistances au cisaillement et à la traction avec l'usage d'une bague standard.

Diese Werte repräsentieren Minimum Scher- und Zugfestigkeiten der Verbindung unter Verwendung von Standard-Schließringen.

I dati indicati in tabella sono minimi e si riferiscono a bulloni installati con collari Standard.

La figura representa los valores mínimos de resistencia a la cortadura y tracción cuando se utiliza collar estándar.

Avdelok® 2801



English	Français	Deutsch	Italiano	Español
Brazier head	Tête plate	Flachrundkopf	Testa tonda	Cabeza alomada
Pin: Aluminium alloy* Polished	Tige: Alliage d'aluminium* Poli	Bolzen: Aluminium* Poliert	Bullone: Lega di alluminio* Lucido	Vástago: Aluminio* Pulido
Collar: Aluminium alloy**	Bague: Alliage d'aluminium**	Schließring: Aluminium**	Collare: Lega di alluminio**	Collar: Aluminio**
Natural	Brut	Blank	Nessuna finitura	Natural

*: AA 2024, DIN 1725, AlCuMg2, Werkstoff 3.1355 **: BS 1473 6061, AA 6061, DIN 1725 AlMg1SiCu, Werkstoff 3.3211

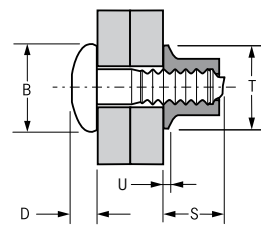
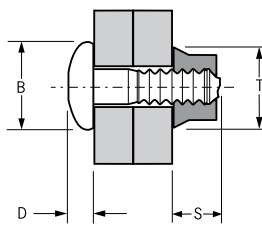
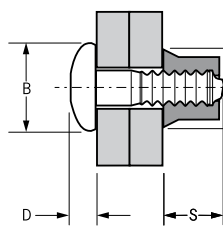
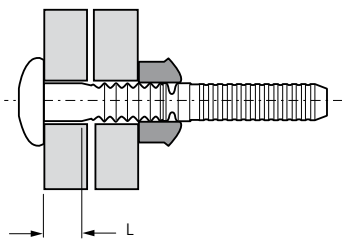

Full Collar
Schließring Standard
Bague Standard
Collare Standard
Collar Estándar

Half Collar
Schließring flach
Bague courte
Collare ribassato
Medio Collar

Flanged Collar
Schließring mit Bund
Bague à embase
Collare flangiato
Collar con Ala

ø	w. Full Collar ²⁾		L	B	D	Part No/ref	Part No/ref		Part No/ref		
	min.	max.					Full Collar		Half Collar ²⁾		Flanged Collar ³⁾
nom.			nom.	max.	max.	Pin ¹⁾	S max.	T max.	S max.	T max.	U ³⁾ nom.
4.8 (3/16")	1.57	4.75	1.57	10.1	3.4	02801-00602	02837-00600	9.4	8.0	02838-00600	02839-00600
	3.18	6.35	3.18			02801-00603					
	4.75	7.92	4.75			02801-00604					
	6.35	9.53	6.35			02801-00605					
	7.92	11.10	7.92			02801-00606					
	9.53	12.70	9.53			02801-00607					
	11.10	14.27	11.10			02801-00608					
	12.70	15.88	12.70			02801-00609					
	14.27	17.45	14.27			02801-00610					
	15.88	19.05	15.88			02801-00611					
	17.45	20.62	17.45			02801-00612					
	19.05	22.23	19.05			02801-00613					
	20.62	23.80	20.62			02801-00614					
	22.23	25.40	22.23			02801-00615					
	23.80	26.97	23.80			02801-00616					
	25.40	28.58	25.40			02801-00617					
	26.97	30.15	26.97			02801-00618					
	28.58	31.75	28.58			02801-00619					
	30.15	33.32	30.15			02801-00620					

all dimensions in mm / en millimètre / alle Maße in mm / in millimetri / en milímetros
1), 2), 3) see page 29 / voir page 29 / siehe Seite 29 / vedi pagina 29 / ver Pág. 29

Avdelok® 2801

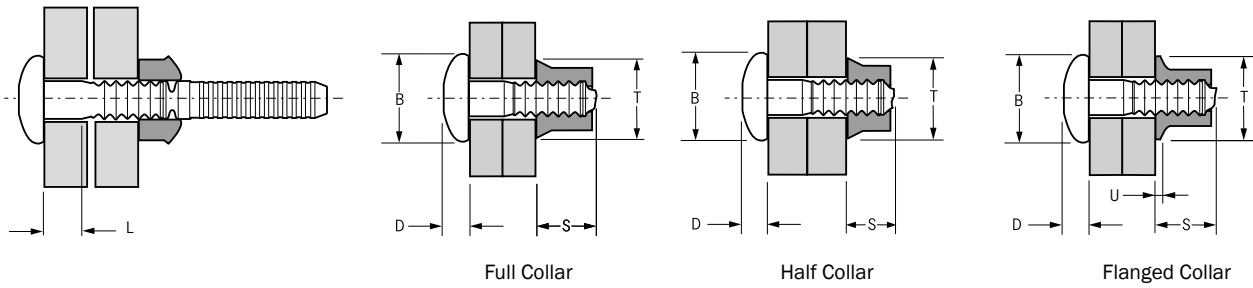

ø nom.	w. Full Collar ²⁾		L nom.	B max.	D max.	Part No/ref Pin ¹⁾	Part No/ref Full Collar		Part No/ref Half Collar ²⁾		Part No/ref Flanged Collar ³⁾			
	min.	max.					S max.	T max.	S max.	T max.	S max.	T max.	U ³⁾ nom.	
6.4 (1/4")	1.57	4.75	6.6	1.57	13.4	4.1	02801-00802	02837-00800	02838-00800	02839-00800	13.2	13.1	0.94	
	3.18	6.35		3.18										02801-00803
	4.75	7.92		4.75										02801-00804
	6.35	9.53		6.35										02801-00805
	7.92	11.10		7.92										02801-00806
	9.53	12.70		9.53										02801-00807
	11.10	14.27		11.10										02801-00808
	12.70	15.88		12.70										02801-00809
	14.27	17.45		14.27										02801-00810
	15.88	19.05		15.88										02801-00811
	17.45	20.62		17.45										02801-00812
	19.05	22.23		19.05										02801-00813
	20.62	23.80		20.62										02801-00814
	22.23	25.40		22.23										02801-00815
23.80	26.97	23.80	02801-00816											
26.97	30.15	26.97	02801-00818											
30.15	33.32	30.15	02801-00820											
31.75	34.93	31.75	02801-00821											
8.0 (5/16")	3.18	9.53	8.2	3.18	16.7	5.5	02801-01004	02837-01000	02838-01000	02839-01000	16.8	16.3	1.22	
	6.35	12.70		6.35										02801-01006
	9.53	15.88		9.53										02801-01008
	12.70	19.05		12.70										02801-01010
	15.88	22.23		15.88										02801-01012
	19.05	25.40		19.05										02801-01014
	22.23	28.58		22.23										02801-01016
	25.40	31.75		25.40										02801-01018
	28.58	34.93		28.58										02801-01020
	31.75	38.10		31.75										02801-01022
	34.93	41.28		34.93										02801-01024
	38.10	44.45		38.10										02801-01026
	41.28	47.63		41.28										02801-01028
	44.45	50.80		44.45										02801-01030
47.63	53.98	47.63	02801-01032											
9.6 (3/8")	3.18	9.53	9.8	3.18	20.0	6.5	02801-01204	02837-01200	02838-01200	02839-01200	20.0	20.0	1.42	
	6.35	12.70		6.35										02801-01206
	9.53	15.88		9.53										02801-01208
	12.70	19.05		12.70										02801-01210

all dimensions in mm / en millimètre / alle Maße in mm / in millimetri / en milímetros
 1), 2), 3) see page 29 / voir page 29 / siehe Seite 29 / vedi pagina 29 / ver Pág. 29

Avdelok® 2801

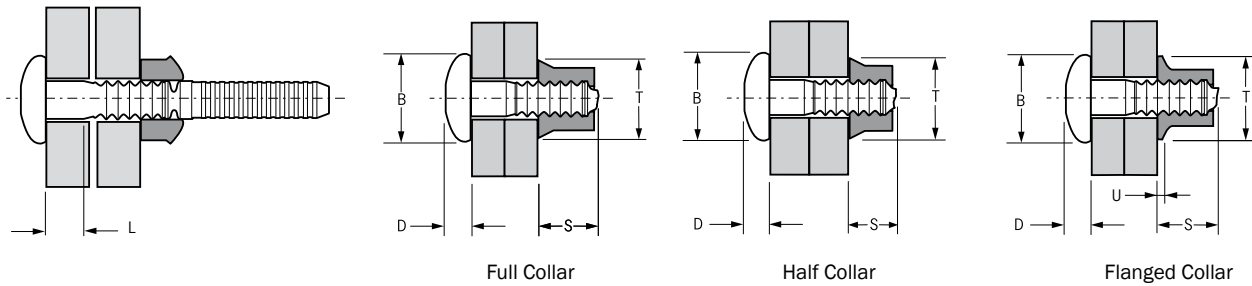

ø nom.	w. Full Collar ²⁾		L nom.	B max.	D max.	Part No/ref Pin ¹⁾	Part No/ref Full Collar		Part No/ref Half Collar ²⁾		Part No/ref Flanged Collar ³⁾		
	min.	max.					S max.	T max.	S max.	T max.	S max.	T max.	U ³⁾ nom.
9.6 (3/8")	15.88	22.23	15.88	20.0	6.5	02801-01212	02837-01200	18.6	15.5	02838-01200	20.0	20.0	1.42
	19.05	25.40	19.05			02801-01214							
	22.23	28.58	22.23			02801-01216							
	25.40	31.75	25.40			02801-01218							
	28.58	34.93	28.58			02801-01220							
	31.75	38.10	31.75			02801-01222							
	34.93	41.28	34.93			02801-01224							
	38.10	44.45	38.10			02801-01226							
	41.28	47.63	41.28			02801-01228							
	44.45	50.80	44.45			02801-01230							
47.63	53.98	47.63	02801-01232										

all dimensions in mm / en millimètre / alle Maße in mm / in millimetri / en milímetros

1) Different grip range pins with different numbers of grooves are available

Tiges avec autres plages de serrage et différent nombre de cannelures sont disponible.

Bolzen mit anderem Klemmbereich und anderer Anzahl von Rillen sind verfügbar

Sono disponibili bulloni con spessori serrabili differenti con diverso numero di scanalature

Disponibles pernos con diferente número de anillos según el espesor a remachar

2) Half collars increase the grip range to that of the next longest pin. Maximum grip increases by 1.57 mm (0.062") for 4.8 mm and 6.4 mm fasteners and 3.18 mm (0.125") for 8.0 mm and 9.6 mm fasteners.

Avec une bague courte, la plage de serrage maximale est équivalente à celle de l'Avdelok de longueur immédiatement supérieure. La plage de serrage augmente de 1.57 mm pour tiges de 4.8 mm et 6.4 mm, et de 3.18 mm pour tiges de 8.0 mm et 9.6 mm.

Die Verwendung von flachen Schließringen erhöht den Klemmbereich auf den des nächstlängeren Bolzens. Der maximale Klemmbereich erhöht sich um 1,6 mm für ø 4,8 mm und ø 6,4 mm Bolzen und 3,2 mm für ø 8,0 mm und ø 9,6 mm Bolzen.

Utilizzando i collari ribassati lo spessore serrabile aumenta, ed è uguale a quello massimo del bullone di misura superiore. Il massimo spessore serrabile aumenta di 1,57 mm per i bulloni da 4,8 mm e 6,4 mm e di 3,18 mm per i bulloni da 8,0 mm e 9,6 mm.

El empleo de medio collar incrementa el máx. espesor a remachar al de la siguiente toma. El máximo espesor a remachar por uso de medio collar es de 1,57 mm para diámetros de 4,8 y 6,4 mm y de 3,18 mm para diámetros de 8 y 9,6 mm.



3) Flanged collars are used in applications where the hole on the collar side of the application is oversize or is slotted for alignment purposes. To determine what length of pin is required, add dimension U to the thickness of material being fastened.

Avec une bague à embase, la plage de serrage est diminuée de la valeur de la cote U.

Schließringe mit Bund werden in Anwendungen benötigt, wo das Bohrloch auf der Schließringseite übergroß oder länglich ist. Um den richtigen Bolzen zu bestimmen, addieren Sie das Maß U zu der zu verbindenden Materialstärke hinzu.

Utilizzando i collari flangiati la dimensione „U“ deve essere aggiunta allo spessore da serrare per determinare il tipo di bullone adatto.

Utilizar collar con ala cuando en la aplicación el taladro está sobredimensionado o es ranurado. Para calcular la referencia de perno necesaria añadir la cota U al espesor de la aplicación.

ø nom.	 kN ⁴⁾	 kN ⁴⁾
4.8 (3/16")	4.67	4.72
6.4 (1/4")	8.34	7.92
8.0 (5/16")	13.02	12.68
9.6 (3/8")	18.69	18.68

4) These figures represent minimum fastener shear and tensile strength values with the use of a full collar. When using half collars tension is reduced to approximately 45 %.

Cette valeurs représentent minimum résistances au cisaillement et à la traction avec l'usage d'une bague standard. Avec l'usage des bagues courtes la résistance à la traction se diminue à env. 45 %.

Diese Werte repräsentieren Minimum Scher- und Zugfestigkeiten der Verbindung unter Verwendung von Standard-Schließringen. Bei Verwendung von flachen Schließringen reduziert sich die Zugfestigkeit auf ca. 45 %.

I dati si riferiscono a bulloni installati con collari Standard, utilizzando collari ribassati i valori di trazione diminuiscono del 45 % circa, i valori di taglio rimangono invariati. I dati indicati in tabella sono minimi.

La figura representa los valores mínimos de resistencia a la cortadura y tracción cuando se utiliza collar estándar. Cuando se utiliza medio collar se reducen aproximadamente en un 45 %.

Avdelok® 2802



English	Français	Deutsch	Italiano	Español
90° Countersunk	90° Tête fraisée	90° Senkkopf	90° Testa svasata	90° Cabeza avellanada
Pin: Aluminium alloy* Polished	Tige: Alliage d'aluminium* Poli	Bolzen: Aluminium* Poliert	Bullone: Lega di alluminio* Lucido	Vástago: Aluminio* Pulido
Collar: Aluminium alloy**	Bague: Alliage d'aluminium**	Schließring: Aluminium**	Collare: Lega di alluminio**	Collar: Aluminio**
Natural	Brut	Blank	Nessuna finitura	Natural

*: AA 2024, DIN 1725, AlCuMg2, Werkstoff 3.1355 **: BS 1473 6061, AA 6061, DIN 1725 AlMg1SiCu, Werkstoff 3.3211

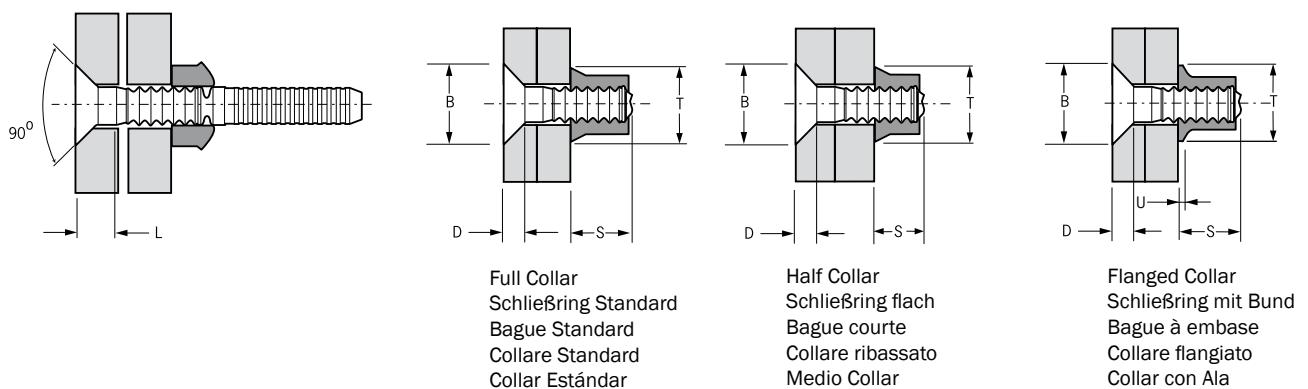

ø	w. Full Collar ²⁾		L	B	D	Part No/ref	Part No/ref		Part No/ref				
	min.	max.					Full Collar	Half Collar ²⁾	Flanged Collar ³⁾				
nom.			nom.	max.	max.	Pin ¹⁾	S max.	T max.	S max.	T max.	S max.	T max.	U ³⁾ nom.
4.8 (3/16")	3.18	6.35	5.0	3.18	8.9	2.2	02802-00603	02837-00600	02838-00600	02839-00600			
	4.75	7.92		4.75			02802-00604						
	6.35	9.53		6.35			02802-00605						
	7.92	11.10		7.92			02802-00606						
	9.53	12.70		9.53			02802-00607						
	11.10	14.27		11.10			02802-00608						
	12.70	15.88		12.70			02802-00609						
	14.27	17.45		14.27			02802-00610						
	15.88	19.05		15.88			02802-00611						
	17.45	20.62		17.45			02802-00612						
	19.05	22.23		19.05			02802-00613						
	20.62	23.80		20.62			02802-00614						
	22.23	25.40		22.23			02802-00615						
	23.80	26.97		23.80			02802-00616						
	25.40	28.58		25.40			02802-00617						
	26.97	30.15		26.97			02802-00618						
28.58	31.75	28.58	02802-00619										
30.15	33.32	30.15	02802-00620										

all dimensions in mm / en millimètre / alle Maße in mm / in millimetri / en milímetros
 1), 2), 3) see page 32 / voir page 32 / siehe Seite 32 / vedi pagina 32 / ver Pág. 32

Avdelok® 2802

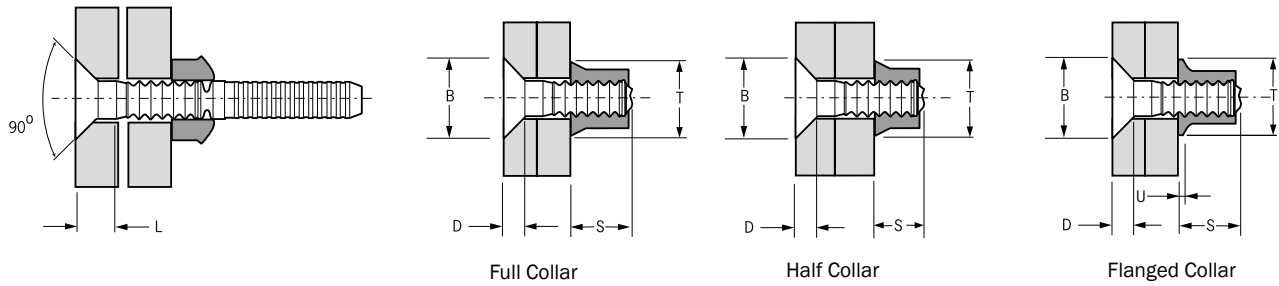

ø nom.	w. Full Collar ²⁾		L nom.	B max.	D max.	Part No/ref Pin ¹⁾	Part No/ref Full Collar		Part No/ref Half Collar ²⁾		Part No/ref Flanged Collar ³⁾		
	min.	max.					S max.	T max.	S max.	T max.	S max.	T max.	U ³⁾ nom.
6.4 (1/4")	3.18	6.35	6.6	3.18	11.8	2.9	02802-00803	02837-00800	02838-00800	02839-00800 13.2 13.1 0.94			
	4.75	7.92		4.75			02802-00804						
	6.35	9.53		6.35			02802-00805						
	7.92	11.10		7.92			02802-00806						
	9.53	12.70		9.53			02802-00807						
	11.10	14.27		11.10			02802-00808						
	12.70	15.88		12.70			02802-00809						
	14.27	17.45		14.27			02802-00810						
	15.88	19.05		15.88			02802-00811						
	17.45	20.62		17.45			02802-00812						
	19.05	22.23		19.05			02802-00813						
	20.62	23.80		20.62			02802-00814						
	22.23	25.40		22.23			02802-00815						
	23.80	26.97		23.80			02802-00816						
26.97	30.15	26.97	02802-00818										
30.15	33.32	30.15	02802-00820										
8.0 (5/16")	3.18	9.53	8.2	3.18	14.8	3.7	02802-01004	02837-01000	02838-01000	02839-01000 16.8 16.3 1.22			
	6.35	12.70		6.35			02802-01006						
	9.53	15.88		9.53			02802-01008						
	12.70	19.05		12.70			02802-01010						
	15.88	22.23		15.88			02802-01012						
	19.05	25.40		19.05			02802-01014						
	22.23	28.58		22.23			02802-01016						
	25.40	31.75		25.40			02802-01018						
	28.58	34.93		28.58			02802-01020						
	31.75	38.10		31.75			02802-01022						
	34.93	41.28		34.93			02802-01024						
	38.10	44.45		38.10			02802-01026						
	41.28	47.63		41.28			02802-01028						
	44.45	50.80		44.45			02802-01030						
47.63	53.98	47.63	02802-01032										
9.6 (3/8")	6.35	12.70	9.8	6.35	17.7	4.4	02802-01206	02837-01200	02838-01200	02839-01200 20.0 20.0 1.42			
	9.53	15.88		9.53			02802-01208						
	12.70	19.05		12.70			02802-01210						
	15.88	22.23		15.88			02802-01212						
	19.05	25.40		19.05			02802-01214						
	22.23	28.58		22.23			02802-01216						

all dimensions in mm / en millimètre / alle Maße in mm / in millimetri / en milímetros
 1), 2), 3) see page 32 / voir page 32 / siehe Seite 32 / vedi pagina 32 / ver Pág. 32

Avdelok® 2802

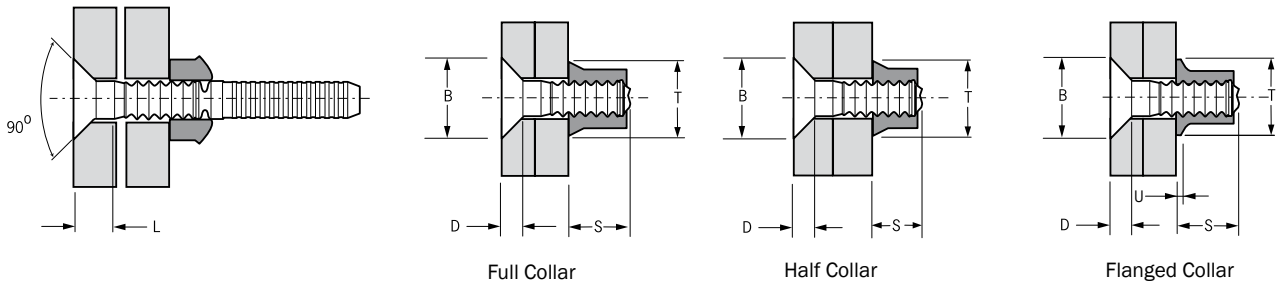

ø nom.	w. Full Collar ²⁾		L nom.	B max.	D max.	Part No/ref Pin ¹⁾	Part No/ref Full Collar		Part No/ref Half Collar ²⁾		Part No/ref Flanged Collar ³⁾			
	min.	max.					S max.	T max.	S max.	T max.	S max.	T max.	U ³⁾ nom.	
9.6 (3/8")	25.40	31.75	9.8	25.40	17.7	4.4	02802-01218	02837-01200	18.6	15.5	02838-01200	20.0	20.0	1.42
	28.58	34.93		02802-01220										
	31.75	38.10		02802-01222										
	34.93	41.28		02802-01224										
	38.10	44.45		02802-01226										
	41.28	47.63		02802-01228										
	44.45	50.80		02802-01230										
	47.63	53.98		02802-01232										

all dimensions in mm / en millimètre / alle Maße in mm / in millimetri / en milímetros

1) Different grip range pins with different numbers of grooves are available

Tiges avec autres plages de serrage et différent nombre de cannelures sont disponible.

Bolzen mit anderem Klemmbereich und anderer Anzahl von Rillen sind verfügbar

Sono disponibili bulloni con spessori serrabili differenti con diverso numero di scanalature

Disponibles pernos con diferente número de anillos según el espesor a remachar

2) Half collars increase the grip range to that of the next longest pin. Maximum grip increases by 1.57 mm (0.062") for 4.8 mm and 6.4 mm fasteners and 3.18 mm (0.125") for 8.0 mm and 9.6 mm fasteners.

Avec une bague courte, la plage de serrage maximale est équivalente à celle de l'Avdelok de longueur immédiatement supérieure. La plage de serrage augmente de 1.57 mm pour tiges de 4.8 mm et 6.4 mm, et de 3.18 mm pour tiges de 8.0 mm et 9.6 mm.

Die Verwendung von flachen Schließringen erhöht den Klemmbereich auf den des nächstlängeren Bolzens. Der maximale Klemmbereich erhöht sich um 1,6 mm für ø 4,8 mm und ø 6,4 mm Bolzen und 3,2 mm für ø 8,0 mm und ø 9,6 mm Bolzen.

Utilizzando i collari ribassati lo spessore serrabile aumenta, ed è uguale a quello massimo del bullone di misura superiore. Il massimo spessore serrabile aumenta di 1.57 mm per i bulloni da 4.8 mm e 6.4 mm e di 3.18 mm per i bulloni da 8.0 mm e 9.6 mm.

El empleo de medio collar incrementa el máx. espesor a remachar al de la siguiente toma. El máximo espesor a remachar por uso de medio collar es de 1,57 mm para diámetros de 4,8 y 6,4 mm y de 3,18 mm para diámetros de 8 y 9,6 mm.



3) Flanged collars are used in applications where the hole on the collar side of the application is oversize or is slotted for alignment purposes. To determine what length of pin is required, add dimension U to the thickness of material being fastened.

Avec une bague à embase, la plage de serrage est diminuée de la valeur de la cote U.

Schließringe mit Bund werden in Anwendungen benötigt, wo das Bohrloch auf der Schließringseite übergroß oder länglich ist. Um den richtigen Bolzen zu bestimmen, addieren Sie das Maß U zu der zu verbindenden Materialstärke hinzu.

Utilizzando i collari flangiati la dimensione „U“ deve essere aggiunta allo spessore da serrare per determinare il tipo di bullone adatto.

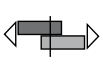
Utilizar collar con ala cuando en la aplicación el taladro está sobredimensionado o es ranurado. Para calcular la referencia de perno necesaria añadir la cota U al espesor de la aplicación.

ø nom.		
	kN ⁴⁾	kN ⁴⁾
4.8 (3/16")	4.67	4.72
6.4 (1/4")	8.34	7.92
8.0 (5/16")	13.02	12.68
9.6 (3/8")	18.69	18.68

4) These figures represent minimum fastener shear and tensile strength values with the use of a full collar. When using half collars tension is reduced to approximately 45 %.

Cette valeurs représentent minimum résistances au cisaillement et à la traction avec l'usage d'une bague standard. Avec l'usage des bagues courtes la résistance à la traction se diminue à env. 45 %.

Diese Werte repräsentieren Minimum Scher- und Zugfestigkeiten der Verbindung unter Verwendung von Standard-Schließringen. Bei Verwendung von flachen Schließringen reduziert sich die Zugfestigkeit auf ca. 45 %.

I dati si riferiscono a bulloni installati con collari Standard, utilizzando collari ribassati i valori di trazione diminuiscono del 45 % circa, i valori di taglio rimangono invariati. I dati indicati in tabella sono minimi.

La figura representa los valores mínimos de resistencia a la cortadura y tracción cuando se utiliza collar estándar. Cuando se utiliza medio collar se reducen aproximadamente en un 45 %.

Avdelok® 2803



English	Français	Deutsch	Italiano	Español
Truss head	Tête large	Flachrundkopf groß	Testa larga	Cabeza alomada de perfil bajo
Pin: Aluminium alloy* Polished	Tige: Alliage d'aluminium* Poli	Bolzen: Aluminium* Poliert	Bullone: Lega di alluminio* Lucido	Vástago: Aluminio* Pulido
Collar: Aluminium alloy** Natural	Bague: Alliage d'aluminium** Brut	Schließring: Aluminium** Blank	Collare: Lega di alluminio** Nessuna finitura	Collar: Aluminio** Natural

*: AA 2024, DIN 1725, AlCuMg2, Werkstoff 3.1355 **: BS 1473 6061, AA 6061, DIN 1725 AlMg1SiCu, Werkstoff 3.3211

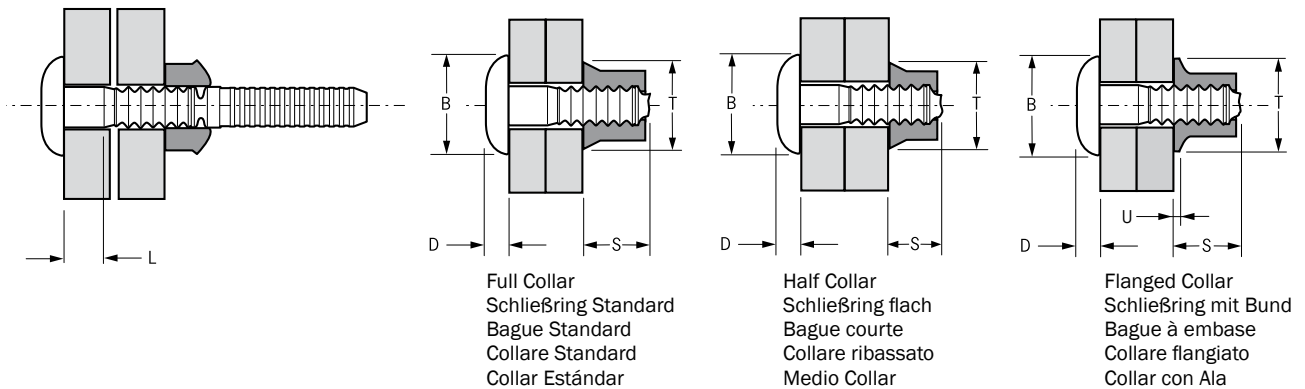

ø	w. Full Collar ²⁾		L	B	D	Part No/ref	Part No/ref		Part No/ref											
	min.	max.					Full Collar	Half Collar ²⁾	Flanged Collar ³⁾											
nom.			nom.	max.	nom.	Pin ¹⁾	S max.	T max.	S max.	T max.	S max.	T max.	U ³⁾ nom.							
4.8 (3/16")	1.57	4.75	5.0	1.57	12.0	2.2	02803-00602	02837-00600	02838-00600	02839-00600										
	3.18	6.35		3.18									02803-00603							
	4.75	7.92		4.75									02803-00604							
	6.35	9.53		6.35									02803-00605							
	7.92	11.10		7.92									02803-00606							
	9.53	12.70		9.53									02803-00607							
	11.10	14.27		11.10									02803-00608							
	12.70	15.88		12.70									02803-00609							
	14.27	17.45		14.27									02803-00610	9.4	8.0	7.9	8.0	10.2	9.9	0.76
	15.88	19.05		15.88									02803-00611							
	17.45	20.62		17.45									02803-00612							
	19.05	22.23		19.05									02803-00613							
	20.62	23.80		20.62									02803-00614							
	22.23	25.40		22.23									02803-00615							
	23.80	26.97		23.80									02803-00616							
	25.40	28.58		25.40									02803-00617							
	26.97	30.15		26.97									02803-00618							
	28.58	31.75		28.58									02803-00619							
	30.15	33.32		30.15									02803-00620							

all dimensions in mm / en millimètre / alle Maße in mm / in millimetri / en milímetros

1), 2), 3) see page 35 / voir page 35 / siehe Seite 35 / vedi pagina 35 / ver Pág. 35

Avdelok® 2803

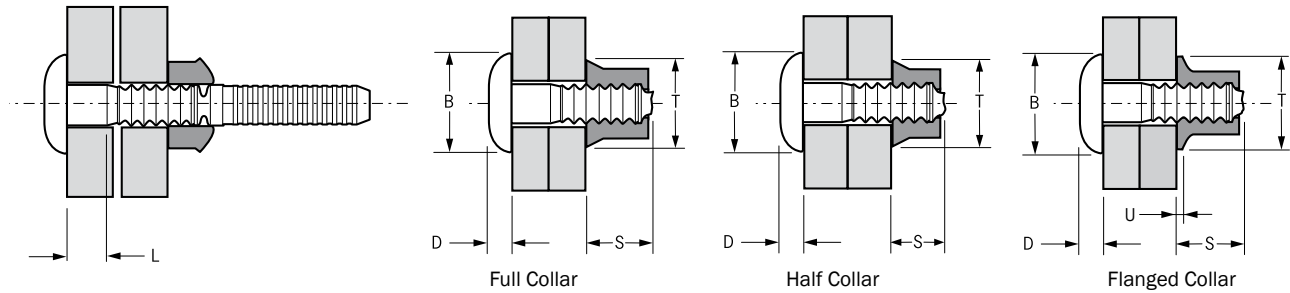

ø nom.	w. Full Collar ²⁾		L nom.	B max.	D nom.	Part No/ref Pin ¹⁾	Part No/ref Full Collar		Part No/ref Half Collar ²⁾		Part No/ref Flanged Collar ³⁾		
	min.	max.					S max.	T max.	S max.	T max.	S max.	T max.	U ³⁾ nom.
6.4 (1/4")	1.57	4.75	1.57	15.1	2.8	02803-00802	02837-00800	12.2 10.6	02838-00800	13.2 13.1 0.94			
	3.18	6.35	3.18			02803-00803							
	4.75	7.92	4.75			02803-00804							
	6.35	9.53	6.35			02803-00805							
	7.92	11.10	7.92			02803-00806							
	9.53	12.70	9.53			02803-00807							
	11.10	14.27	11.10			02803-00808							
	12.70	15.88	12.70			02803-00809							
	14.27	17.45	14.27			02803-00810							
	15.88	19.05	15.88			02803-00811							
	17.45	20.62	17.45			02803-00812							
	19.05	22.23	19.05			02803-00813							
	20.62	23.80	20.62			02803-00814							
	22.23	25.40	22.23			02803-00815							
	23.80	26.97	23.80			02803-00816							
	26.97	30.15	26.97			02803-00818							
30.15	33.32	30.15	02803-00820										
31.75	34.93	31.75	02803-00821										
8.0 (5/16")	3.18	9.53	3.18	19.9	3.6	02803-01004	02837-01000	15.5 13.3	02838-01000	16.8 16.3 1.22			
	6.35	12.70	6.35			02803-01006							
	9.53	15.88	9.53			02803-01008							
	12.70	19.05	12.70			02803-01010							
	15.88	22.23	15.88			02803-01012							
	19.05	25.40	19.05			02803-01014							
	22.23	28.58	22.23			02803-01016							
	25.40	31.75	25.40			02803-01018							
	28.58	34.93	28.58			02803-01020							
	31.75	38.10	31.75			02803-01022							
	34.93	41.28	34.93			02803-01024							
	38.10	44.45	38.10			02803-01026							
	41.28	47.63	41.28			02803-01028							
	44.45	50.80	44.45			02803-01030							
47.63	53.98	47.63	02803-01032										
9.6 (3/8")	3.18	9.53	3.18	23.5	4.1	02803-01204	02837-01200	18.6 15.5	02838-01200	20.0 20.0 1.42			
	6.35	12.70	6.35			02803-01206							
	9.53	15.88	9.53			02803-01208							
	12.70	19.05	12.70			02803-01210							

all dimensions in mm / en millimètre / alle Maße in mm / in millimetri / en milímetros

1), 2), 3) see page 35 / voir page 35 / siehe Seite 35 / vedi pagina 35 / ver Pág. 35

Avdelok® 2803

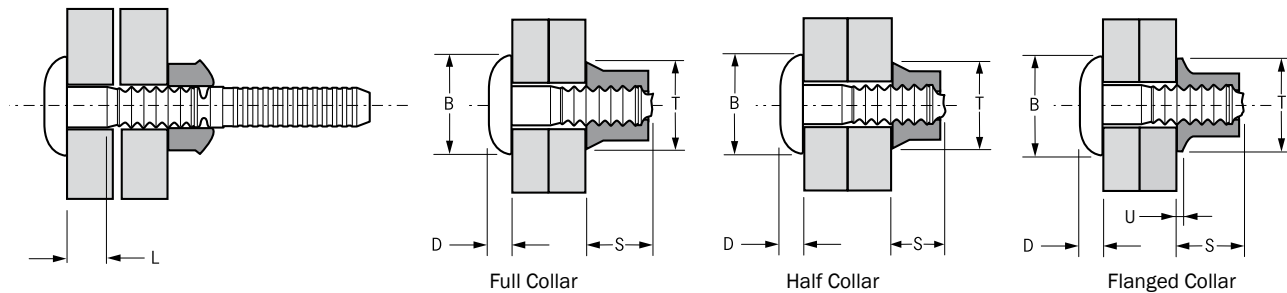

ø nom.	w. Full Collar ²⁾		L nom.	B max.	D nom.	Part No/ref Pin ¹⁾	Part No/ref Full Collar		Part No/ref Half Collar ²⁾		Part No/ref Flanged Collar ³⁾			
	min.	max.					S max.	T max.	S max.	T max.	S max.	T max.	U ³⁾ nom.	
9.6 (3/8")	15.88	22.23	9.8	15.88	23.5	4.1	02803-01212	18.6	15.5	15.5	20.0	20.0	1.42	
	19.05	25.40		19.05										02803-01214
	22.23	28.58		22.23										02803-01216
	25.40	31.75		25.40										02803-01218
	28.58	34.93		28.58										02803-01220
	31.75	38.10		31.75										02803-01222
	34.93	41.28		34.93										02803-01224
	38.10	44.45		38.10										02803-01226
	41.28	47.63		41.28										02803-01228
	44.45	50.80		44.45										02803-01230
47.63	53.98	47.63	02803-01232											

all dimensions in mm / en millimètre / alle Maße in mm / in millimetri / en milímetros

1) Different grip range pins with different numbers of grooves are available

Tiges avec autres plages de serrage et différent nombre de cannelures sont disponible.

Bolzen mit anderem Klemmbereich und anderer Anzahl von Rillen sind verfügbar

Sono disponibili bulloni con spessori serrabili differenti con diverso numero di scanalature

Disponibles pernos con diferente número de anillos según el espesor a remachar

2) Half collars increase the grip range to that of the next longest pin. Maximum grip increases by 1.57 mm (0.062") for 4.8 mm and 6.4 mm fasteners and 3.18 mm (0.125") for 8.0 mm and 9.6 mm fasteners.

Avec une bague courte, la plage de serrage maximale est équivalente à celle de l'Avdelok de longueur immédiatement supérieure. La plage de serrage augmente de 1.57 mm pour tiges de 4.8 mm et 6.4 mm, et de 3.18 mm pour tiges de 8.0 mm et 9.6 mm.

Die Verwendung von flachen Schließringen erhöht den Klemmbereich auf den des nächstlängeren Bolzens. Der maximale Klemmbereich erhöht sich um 1,6 mm für ø 4,8 mm und ø 6,4 mm Bolzen und 3,2 mm für ø 8,0 mm und ø 9,6 mm Bolzen.

Utilizzando i collari ribassati lo spessore serrabile aumenta, ed è uguale a quello massimo del bullone di misura superiore. Il massimo spessore serrabile aumenta di 1.57 mm per i bulloni da 4.8 mm e 6.4 mm e di 3.18 mm per i bulloni da 8.0 mm e 9.6 mm.

El empleo de medio collar incrementa el máx. espesor a remachar al de la siguiente toma. El máximo espesor a remachar por uso de medio collar es de 1,57 mm para diámetros de 4,8 y 6,4 mm y de 3,18 mm para diámetros de 8 y 9,6 mm.



3) Flanged collars are used in applications where the hole on the collar side of the application is oversize or is slotted for alignment purposes. To determine what length of pin is required, add dimension U to the thickness of material being fastened.

Avec une bague à embase, la plage de serrage est diminuée de la valeur de la cote U.

Schließringe mit Bund werden in Anwendungen benötigt, wo das Bohrloch auf der Schließringseite übergroß oder länglich ist. Um den richtigen Bolzen zu bestimmen, addieren Sie das Maß U zu der zu verbindenden Materialstärke hinzu.

Utilizzando i collari flangiati la dimensione „U“ deve essere aggiunta allo spessore da serrare per determinare il tipo di bullone adatto.

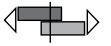
Utilizar collar con ala cuando en la aplicación el taladro está sobredimensionado o es ranurado. Para calcular la referencia de perno necesaria añadir la cota U al espesor de la aplicación.

ø nom.		
	kN ⁴⁾	kN ⁴⁾
4.8 (3/16")	4.67	4.72
6.4 (1/4")	8.34	7.92
8.0 (5/16")	13.02	12.68
9.6 (3/8")	18.69	18.68

4) These figures represent minimum fastener shear and tensile strength values with the use of a full collar. When using half collars tension is reduced to approximately 45 %.

Cette valeurs représentent minimum résistances au cisaillement et à la traction avec l'usage d'une bague standard. Avec l'usage des bagues courtes la résistance à la traction se diminue à env. 45 %.

Diese Werte repräsentieren Minimum Scher- und Zugfestigkeiten der Verbindung unter Verwendung von Standard-Schließringen. Bei Verwendung von flachen Schließringen reduziert sich die Zugfestigkeit auf ca. 45 %.

I dati si riferiscono a bulloni installati con collari Standard, utilizzando collari ribassati i valori di trazione diminuiscono del 45 % circa, i valori di taglio rimangono invariati. I dati indicati in tabella sono minimi.

La figura representa los valores mínimos de resistencia a la cortadura y tracción cuando se utiliza collar estándar. Cuando se utiliza medio collar se reducen aproximadamente en un 45 %.

Avdelok® 2804



English	Français	Deutsch	Italiano	Español
Large head	Tête large	Rundkopf extragroß	Testa larga	Cabeza ancha
Pin: Aluminium alloy* Polished	Tige: Alliage d'aluminium* Poli	Bolzen: Aluminium* Poliert	Bullone: Lega di alluminio* Lucido	Vástago: Aluminio** Pulido
Collar: Aluminium alloy**	Bague: Alliage d'aluminium**	Schließring: Aluminium**	Collare: Lega di alluminio**	Collar: Aluminio**
Natural	Brut	Blank	Nessuna finitura	Natural

*: AA 2024, DIN 1725, AlCuMg2, Werkstoff 3.1355 **: BS 1473 6061, AA 6061, DIN 1725 AlMg1SiCu, Werkstoff 3.3211

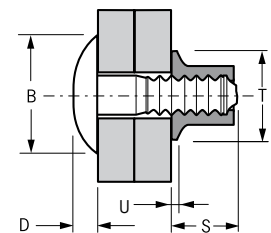
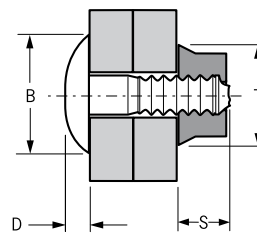
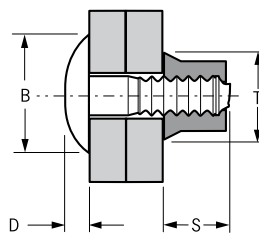
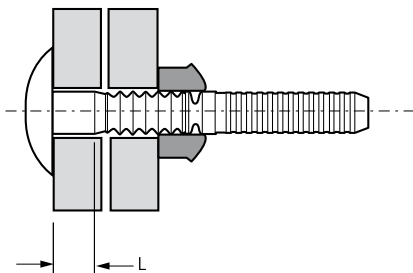

Full Collar
Schließring Standard
Bague Standard
Collare Standard
Collar Estándar

Half Collar
Schließring flach
Bague courte
Collare ribassato
Medio Collar

Flanged Collar
Schließring mit Bund
Bague à embase
Collare flangiato
Collar con Ala

Ø	w. Full Collar ²⁾		L	B	D	Part No/ref	Part No/ref		Part No/ref		
	min.	max.					Full Collar		Half Collar ²⁾		Flanged Collar ³⁾
nom.			nom.	max.	nom.	Pin ¹⁾	S max.	T max.	S max.	T max.	U ³⁾ nom.
9.6 (3/8")	9.53	15.88	9.53	32.2	5.0	02804-01208	02837-01200	18.6	15.5	02838-01200	02839-01200
	12.70	19.05	12.70			02804-01210					
	15.88	22.23	15.88			02804-01212					
	19.05	25.40	19.05			02804-01214					
	22.23	28.58	22.23			02804-01216					
	25.40	31.75	25.40			02804-01218					
	28.58	34.93	28.58			02804-01220					
	31.75	38.10	31.75			02804-01222					
	34.93	41.28	34.93			02804-01224					
	38.10	44.45	38.10			02804-01226					
	41.28	47.63	41.28			02804-01228					
	44.45	50.80	44.45			02804-01230					
	47.63	53.98	47.63			02804-01232					

all dimensions in mm / en millimètre / alle Maße in mm / in millimetri / en milímetros

1), 2), 3) see page 37 / voir page 2 / siehe Seite 37 / vedi pagina 37 / ver Pág. 37

Avdelok® 2804

1) Different grip range pins with different numbers of grooves are available

Tiges avec autres plages de serrage et different nombre de cannelures sont disponible.

Bolzen mit anderem Klemmbereich und anderer Anzahl von Rillen sind verfügbar

Sono disponibili bulloni con spessori serrabili differenti con diverso numero di scanalature

Disponibles pernos con diferente número de anillos según el espesor a remachar

2) Half collars increase the grip range to that of the next longest pin. Maximum grip increases by 1.57 mm (0.062") for 4.8 mm and 6.4 mm fasteners and 3.18 mm (0.125") for 8.0 mm and 9.6 mm fasteners.

Avec une bague courte, la plage de serrage maximale est équivalente à celle de l'Avdelok de longueur immédiatement supérieure. La plage de serrage augmente de 1.57 mm pour tiges de 4.8 mm et 6.4 mm, et de 3.18 mm pour tiges de 8.0 mm et 9.6 mm.

Die Verwendung von flachen Schließringen erhöht den Klemmbereich auf den des nächstlängeren Bolzens. Der maximale Klemmbereich erhöht sich um 1,6 mm für \varnothing 4,8 mm und \varnothing 6,4 mm Bolzen und 3,2 mm für \varnothing 8,0 mm und \varnothing 9,6 mm Bolzen.

Utilizzando i collari ribassati lo spessore serrabile aumenta, ed è uguale a quello massimo del bullone di misura superiore. Il massimo spessore serrabile aumenta di 1.57 mm per i bulloni da 4.8 mm e 6.4 mm e di 3.18 mm per i bulloni da 8.0 mm e 9.6 mm.

El empleo de medio collar incrementa el máx. espesor a remachar al de la siguiente toma. El máximo espesor a remachar por uso de medio collar es de 1,57 mm para diámetros de 4,8 y 6,4 mm y de 3,18 mm para diámetros de 8 y 9,6 mm.



3) Flanged collars are used in applications where the hole on the collar side of the application is oversize or is slotted for alignment purposes. To determine what length of pin is required, add dimension U to the thickness of material being fastened.

Avec une bague à embase, la plage de serrage est diminuée de la valeur de la cote U.

Schließringe mit Bund werden in Anwendungen benötigt, wo das Bohrloch auf der Schließringseite übergroß oder länglich ist. Um den richtigen Bolzen zu bestimmen, addieren Sie das Maß U zu der zu verbindenden Materialstärke hinzu.

Utilizzando i collari flangiati la dimensione „U“ deve essere aggiunta allo spessore da serrare per determinare il tipo di bullone adatto.

Utilizar collar con ala cuando en la aplicación el taladro está sobredimensionado o es ranurado. Para calcular la referencia de perno necesaria añadir la cota U al espesor de la aplicación.

\varnothing		
nom.	kN ⁴⁾	kN ⁴⁾
9.6 (3/8")	18.69	18.68

4) These figures represent minimum fastener shear and tensile strength values with the use of a full collar. When using half collars tension is reduced to approximately 45 %.

Cette valeurs représentent minimum résistances au cisaillement et à la traction avec l'usage d'une bague standard. Avec l'usage des bagues courtes la résistance à la traction se diminue à env. 45 %.

Diese Werte repräsentieren Minimum Scher- und Zugfestigkeiten der Verbindung unter Verwendung von Standard-Schließringen. Bei Verwendung von flachen Schließringen reduziert sich die Zugfestigkeit auf ca. 45 %.

I dati si riferiscono a bulloni installati con collari Standard, utilizzando collari ribassati i valori di trazione diminuiscono del 45 % circa, i valori di taglio rimangono invariati. I dati indicati in tabella sono minimi.

La figura representa los valores mínimos de resistencia a la cortadura y tracción cuando se utiliza collar estándar. Cuando se utiliza medio collar se reducen aproximadamente en un 45 %.

Avdelok® LD 2861



English	Français	Deutsch	Italiano	Español
Round head	Tête plate	Rundkopf	Testa tonda	Cabeza alomada
Pin: Carbon steel	Tige: Acier	Bolzen: Stahl	Bullone: Acciaio	Vástago: Acero
Black self-colour	Noir	Schwarz	Negro	Pavonado
Collar: Low carbon steel	Bague: Acier	Schließring: Stahl	Collare: Acciaio	Collar: Acero
Zinc plated	Zingué	Verzinkt	Zincato	Zincado

For Avdelok® LD with countersunk head replace part no 02861 with 02871.
 Pour un Avdelok® LD avec tête fraisée remplacer la référence 02861 par 02871.
 Für Avdelok® LD mit Senkkopf ersetzen Sie die Artikel-Nr. 02861 durch 02871.
 Per Avdelok® LD con testa svasata sostituire il codice 02861 con 02871.
 Para Avdelok® de Gran Diámetro con cabeza avellanada, sustituir en la referencia 02861 por 02871.

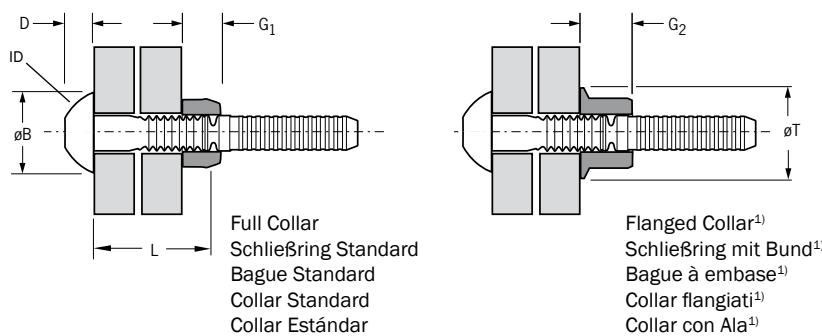

ø nom.					L nom.	ø B max.	D max.	G1 max.	G2 max.	ø T max.	Part No/ref		
	Pin	Full Collar	Flanged Collar ¹⁾										
12.7 (1/2")	6	6.0	13.0	13.2 - 14.3	32.0	23.0	9.2	15.9	19.2	26.2	02861-01604	02662-01600	02615-01600
	12	12.0	19.0		38.0						02861-01608		
	18	18.0	25.0		44.0						02861-01612		
	24	24.0	31.0		50.0						02861-01616		
	31	31.0	38.0		57.0						02861-01620		
	37	37.0	44.0		63.0						02861-01624		
	44	44.0	51.0		70.0						02861-01628		
	50	50.0	57.0		76.0						02861-01632		
	57	57.0	64.0		83.0						02861-01636		
	63	63.0	70.0		89.0						02861-01640		
	70	70.0	77.0		96.0						02861-01644		
	77	77.0	84.0		103.0						02861-01648		
	83	83.0	90.0		109.0						02861-01652		
	89	89.0	96.0		115.0						02861-01656		
95	95.0	102.0	121.0	02861-01660									
15.9 (5/8")	6	6.0	13.0	16.4 - 17.5	36.0	30.0	11.3	21.9	24.3	32.3	02861-02004	02662-02000	02615-02000
	12	12.0	19.0		42.0						02861-02008		
	18	18.0	25.0		48.0						02861-02012		
	24	24.0	31.0		54.0						02861-02016		
	31	31.0	38.0		61.0						02861-02020		

all dimensions in mm / en millimètres / alle Maße in mm / in millimetri / en milímetros

1) see page 40 / voir page 40 / siehe Seite 40 / vedi pagina 40 / ver Pág.40

Avdelok® LD 2861

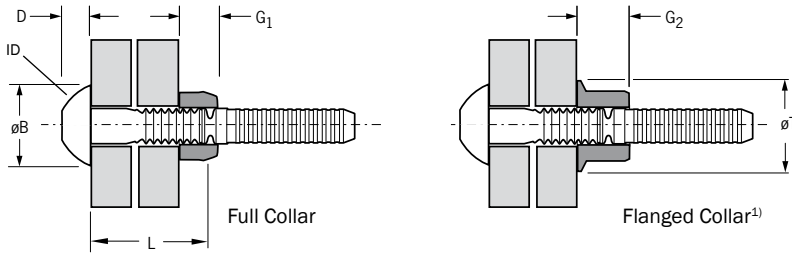

ø nom.					L nom.	ø B max.	D max.	G1 max.	G2 max.	ø T max.	Part No/ref		
	Pin	Full Collar	Flanged Collar ¹⁾										
15.9 (5/8")	37	37.0	44.0	16.4 - 17.5	67.0	30.0	11.3	21.9	24.3	32.3	02861-02024	02662-02000	02615-02000
	44	44.0	51.0		74.0						02861-02028		
	50	50.0	57.0		80.0						02861-02032		
	57	57.0	64.0		87.0						02861-02036		
	63	63.0	70.0		93.0						02861-02040		
	70	70.0	77.0		100.0						02861-02044		
	77	77.0	84.0		107.0						02861-02048		
	83	83.0	90.0		113.0						02861-02052		
	89	89.0	96.0		119.0						02861-02056		
	95	95.0	102.0		125.0						02861-02060		
	19.1 (3/4")	6	6.0		13.0						19.6 - 20.7		
12		12.0	19.0	45.0	02861-02408								
18		18.0	25.0	51.0	02861-02412								
24		24.0	31.0	57.0	02861-02416								
31		31.0	38.0	64.0	02861-02420								
37		37.0	44.0	70.0	02861-02424								
44		44.0	51.0	77.0	02861-02428								
50		50.0	57.0	83.0	02861-02432								
57		57.0	64.0	90.0	02861-02436								
63		63.0	70.0	96.0	02861-02440								
70		70.0	77.0	103.0	02861-02444								
77		77.0	84.0	110.0	02861-02448								
83		83.0	90.0	116.0	02861-02452								
89		89.0	96.0	122.0	02861-02456								
95		95.0	102.0	128.0	02861-02460								
22.2 (7/8")	6	6.0	13.0	22.8 - 23.8	42.0	41.0	15.3	28.2	33.7	41.0	02861-02804	02662-02800	02615-02800
	12	12.0	19.0		48.0						02861-02808		
	18	18.0	25.0		54.0						02861-02812		
	24	24.0	31.0		60.0						02861-02816		
	31	31.0	38.0		67.0						02861-02820		
	37	37.0	44.0		73.0						02861-02824		
	44	44.0	51.0		80.0						02861-02828		
	50	50.0	57.0		86.0						02861-02832		
	57	57.0	64.0		93.0						02861-02836		
	63	63.0	70.0		99.0						02861-02840		

all dimensions in mm / en millimètres / alle Maße in mm / in millimetri / en milímetros

1) see page 40 / voir page 40 / siehe Seite 40 / vedi pagina 40 / ver Pąg.40

Avdelok® LD 2861

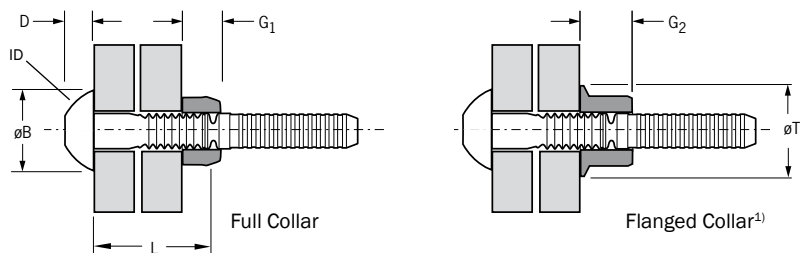

ø nom.					L nom.	ø B max.	D max.	G1 max.	G2 max.	ø T max.	Part No/ref		
	ID	min.	max.								Pin	Full Collar	Flanged Collar ¹⁾
22.2 (7/8")	70	70.0	77.0	22.8 - 23.8	106.0	41.0	15.3	28.2	33.7	41.0	02861-02844	02662-02800	02615-02800
	77	77.0	84.0		113.0						02861-02848		
	83	83.0	90.0		119.0						02861-02852		
	89	89.0	96.0		125.0						02861-02856		
	95	95.0	102.0		131.0						02861-02860		
25.4 (1")	6	6.0	13.0	26.0 - 27.0	46.0	47.0	17.7	32.0	38.0	48.5	02861-03204	02662-03200	02615-03200
	12	12.0	19.0		52.0						02861-03208		
	18	18.0	25.0		58.0						02861-03212		
	24	24.0	31.0		64.0						02861-03216		
	31	31.0	38.0		71.0						02861-03220		
	37	37.0	44.0		77.0						02861-03224		
	44	44.0	51.0		84.0						02861-03228		
	50	50.0	57.0		90.0						02861-03232		
	57	57.0	64.0		97.0						02861-03236		
	63	63.0	70.0		103.0						02861-03240		
	70	70.0	77.0		110.0						02861-03244		
	77	77.0	84.0		117.0						02861-03248		
	83	83.0	90.0		123.0						02861-03252		
	89	89.0	96.0		129.0						02861-03256		
	95	95.0	102.0		135.0						02861-03260		

all dimensions in mm / en millimètres / alle Maße in mm / in millimetri / en milímetros

1) Use of a flanged collar reduces the stated grip range as follows: / L'utilisation d'une bague à embase réduit la plage de serrage de : / Bei Verwendung eines Schließringes mit Bund reduziert sich der angegebene Klemmbereich um die genannten Werte: / L'uso del collare flangiato riduce il campo dello spessore serrabile come segue: / El empleo de collares con ala reduce los espesores a remachar indicados en: ø 12.7 mm: 3 mm; ø 15.9 mm: 4 mm; ø 19.1 mm: 5 mm; ø 22.2 mm: 5.5 mm; ø 25.4 mm: 6 mm

ø nom.			
	kN	kN	kN
12.7 (1/2")	64.0	75.8	53.6
15.9 (5/8")	100.0	120.5	85.4
19.1 (3/4")	144.1	178.4	126.3
22.2 (7/8")	193.0	246.6	174.6
25.4 (1")	251.3	323.4	229.1

Installed Avdelok® LD fasteners provide a minimum shear, tensile and pre-load strength, which is equivalent to or exceeds property class 8.8 or ASTM A-325 standards. Made to British Standard B7805: Part 2:1997, the Avdelok® LD fastener is the perfect alternative to grade 8.8 threaded fasteners, providing a permanent, high tensile friction grip joint but without the risk of loosening.

Une fois posées les fixations Avdelok® LD proposent des performances de résistance au cisaillement et à l'arrachement et une pré-tension qui sont équivalentes ou meilleures que les propriétés d'une classe 8.8 ou de la norme ASTM A-325. Fabriquée selon la norme Anglaise B7805: Part 2:1997, la fixation Avdelok® LD est une parfaite alternative aux boulons de classe 8.8 et offre un assemblage permanent, haute résistance sans risque de desserrage.

Verarbeitete Avdelok® LD Schließringbolzen bieten Mindestwerte für Scher- und Zugbruchlast sowie Vorspannkraft, die der Festigkeitsklasse 8.8 oder ASTM A-325 Standards entsprechen oder übertreffen. Avdelok® LD werden nach British Standard B7805: Part 2:1997 hergestellt. Sie sind die perfekte Alternative zu 8.8 Gewindeprodukten und bieten eine dauerhafte, hochfest vorgespannte Verbindung ohne Risiko des ungewollten Lösen.

I bulloni a strappo Avdelok® LD, una volta installati sono paragonabili o superiori alle classi di resistenza 8.8 o ASTM A-325. Costruiti secondo le norme Britanniche B7805: Parte 2:1997, i bulloni a strappo Avdelok® LD sono perfettamente alternativi al grado di resistenza 8.8. dei bulloni tradizionali, garantendo però un sicuro e permanente serraggio senza rischi di manomissione.

Los remaches Avdelok® LD proporcionan una resistencia a cortadura y a tracción y proporcionan una fuerza de apriete, equivalentes o superiores a la tornillería de clase 8.8 o ASTM A-325. Fabricados bajo la norma British Standard B7805, parte 2:1997, los remaches Avdelok® LD son la alternativa perfecta a la tornillería de clase 8.8, proporcionando una alta fricción permanente entre las piezas a unir sin el riesgo de aflojamiento que tienen las uniones atornilladas.

Maxlok® 1901



English	Français	Deutsch	Italiano	Español
Brazier head	Tête plate	Flachrundkopf	Testa tonda	Cabeza alomada
Pin: Medium carbon steel* Zinc plated Clear trivalent passivated	Tige: Acier* Revêtement zingué Passivation claire trivalente	Bolzen: Stahl* Verzinkt Klar chromatiert, Cr6-frei	Bullone: Acciaio a carbonio* Zincato Passivazione chiara trivalente	Vástago: Acero medio al carbono* Zincado Pasivado claro trivalente
Collar: Low carbon steel** Zinc plated Clear trivalent passivated	Bague: Acier bas carbone** Revêtement zingué Passivation claire trivalente	Schließring: Stahl** Verzinkt Klar chromatiert, Cr6-frei	Collare: Acciaio a basso tenore di carbonio** Zincato Passivazione chiara trivalente	Collar: Acero bajo en carbono** Zincado Pasivado claro trivalente

*: BS 3111 Type 10, SAE 10B35 DIN 1654, 35B2 **: SAE 1008 EN 10263-2 C8C

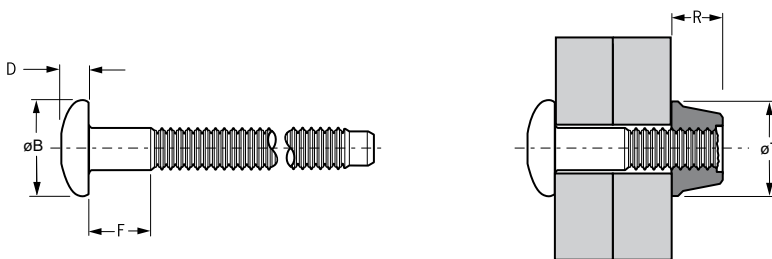

ø	Ø		ØB	D	F	R	øT	kN ¹⁾	kN ¹⁾	Part No/ref	Part No/ref	
	min.	max.										max.
4.8 (3/16")	1.6	15.9	5.16	10.1	3.2	2.3	8.7	10.1	8.25	10.01	01901-70610	01981-70600
	7.9	31.7									01901-70620	
6.4 (1/4")	1.6	15.9	6.75	13.3	3.9	2.2	13.5	13.2	11.79	16.01	01901-70810	01981-70800
	7.9	31.7									01901-70820	

all dimensions in mm / en millimètre / alle Maße in mm / in millimetri / en milímetros

1) typical values / valeurs moyennes / typische Werte / Valori tipici / resistencias máximas recomendadas

Maxlok® 1902



English	Français	Deutsch	Italiano	Español
90° Countersunk	90° Tête fraisée	90° Senkkopf	90° Testa svasata	90° Cabeza avellanada
Pin: Medium carbon steel* Zinc plated Clear trivalent passivated	Tige: Acier* Revêtement zingué Passivation claire trivalente	Bolzen: Stahl* Verzinkt Klar chromatiert, Cr6-frei	Bullone: Acciaio a carbonio* Zincato Passivazione chiara trivalente	Vástago: Acero medio al carbono* Zincado Pasivado claro trivalente
Collar: Low carbon steel** Zinc plated Clear trivalent passivated	Bague: Acier bas carbone** Revêtement zingué Passivation claire trivalente	Schließring: Stahl** Verzinkt Klar chromatiert, Cr6-frei	Collare: Acciaio a basso tenore di carbonio** Zincato Passivazione chiara trivalente	Collar: Acero bajo en carbono** Zincado Pasivado claro trivalente

*: BS 3111 Type 10, SAE 10B35, DIN 1654, 35B2 **: SAE 1008 EN 10263-2 C8C

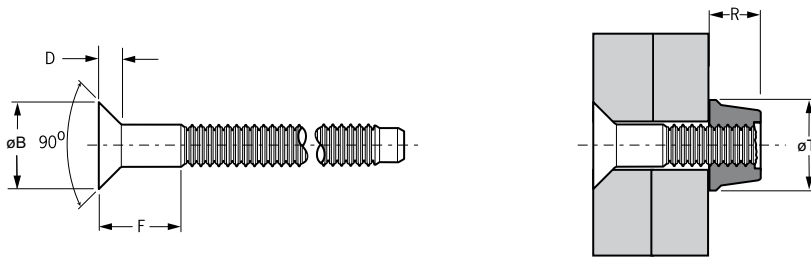

ø	Ø		ØB	D	F	R	øT	kN ¹⁾	kN ¹⁾	Part No/ref	Part No/ref	
	min.	max.										max.
4.8 (3/16")	2.4	15.9	5.16	8.9	2.2	4.3	8.7	10.1	8.25	10.01	01902-70610	01981-70600
	7.9	31.7				9.4					01902-70620	

all dimensions in mm / en millimètre / alle Maße in mm / in millimetri / en milímetros

1) typical values / valeurs moyennes / typische Werte / Valori tipici / resistencias máximas recomendadas

Maxlok® 1903



English	Français	Deutsch	Italiano	Español
Mushroom head	Tête large	Rundkopf groß	Testa larga	Cabeza alomada de perfil alto
Pin: Medium carbon steel* Zinc plated Clear trivalent passivated	Tige: Acier* Revêtement zingué Passivation claire trivalente	Bolzen: Stahl* Verzinkt Klar chromatiert, Cr6-frei	Bullone: Acciaio a carbonio* Zincato Passivazione chiara trivalente	Vástago: Acero medio al carbono* Zincado Pasivado claro trivalente
Collar: Low carbon steel** Zinc plated Clear trivalent passivated	Bague: Acier bas carbone** Revêtement zingué Passivation claire trivalente	Schließring: Stahl** Verzinkt Klar chromatiert, Cr6-frei	Collare: Acciaio a basso tenore di carbonio** Zincato Passivazione chiara trivalente	Collar: Acero bajo en carbono** Zincado Pasivado claro trivalente

*: BS 3111 Type 10, SAE 10B35, DIN 1654, 35B2 **: SAE 1008 EN 10263-2 C8C

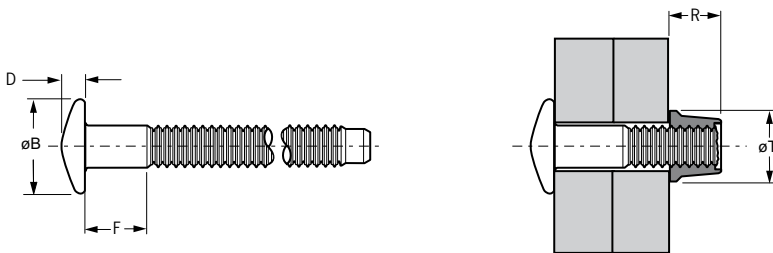

ø	[Diagram]		[Diagram]	øB	D	F	R	øT	[Diagram]	[Diagram]	Part No/ref	Part No/ref
	min.	max.										
4.8 (3/16")	1.6	15.9	5.16	12.5	2.9	2.3	8.7	10.1	8.25	10.01	01903-70610	01981-70600
	7.9	31.7				8.4					01903-70620	
6.4 (1/4")	1.6	15.9	6.75	16.7	3.2	2.2	13.5	13.2	11.79	16.01	01903-70810	01981-70800
	7.9	31.7				9.1					01903-70820	
	27.9	51.7				29.1					01903-70832	

all dimensions in mm / en millimètre / alle Maße in mm / in millimetri / en milímetros

1) typical values / valeurs moyennes / typische Werte / Valori tipici / resistencias máximas recomendadas

Maxlok® 1905



English	Français	Deutsch	Italiano	Español
Truss head	Tête large	Flachrundkopf groß	Testa larga	Cabeza alomada de perfil bajo
Pin: Medium carbon steel* Zinc plated Clear trivalent passivated	Tige: Acier* Revêtement zingué Passivation claire trivalente	Bolzen: Stahl* Verzinkt Klar chromatiert, Cr6-frei	Bullone: Acciaio a carbonio* Zincato Passivazione chiara trivalente	Vástago: Acero medio al carbono* Zincado Pasivado claro trivalente
Collar: Low carbon steel** Zinc plated Clear trivalent passivated	Bague: Acier bas carbone** Revêtement zingué Passivation claire trivalente	Schließring: Stahl** Verzinkt Klar chromatiert, Cr6-frei	Collare: Acciaio a basso tenore di carbonio** Zincato Passivazione chiara trivalente	Collar: Acero bajo en carbono** Zincado Pasivado claro trivalente

*: BS 3111 Type 10, SAE 10B35, DIN 1654, 35B2 **: SAE 1008 EN 10263-2 C8C

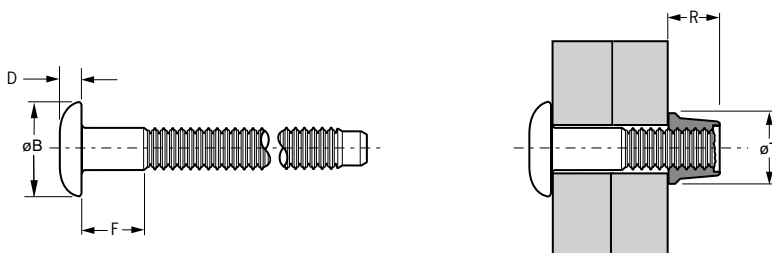

ø	Ø		ØB	D	F	R	øT	kN ¹⁾	kN ¹⁾	Part No/ref	Part No/ref	
	min.	max.										max.
4.8 (3/16")	1.6	15.9	5.16	12.0	2.9	2.3	8.7	10.1	8.25	10.01	01905-70610	01981-70600
	7.9	31.7									01905-70620	
6.4 (1/4")	1.6	15.9	6.75	15.2	3.1	2.2	13.5	13.2	11.79	16.01	01905-70810	01981-70800
	7.9	31.7									01905-70820	

all dimensions in mm / en millimètre / alle Maße in mm / in millimetri / en milímetros

1) typical values / valeurs moyennes / typische Werte / Valori tipici / resistencias máximas recomendadas

Maxlok® 1921



English	Français	Deutsch	Italiano	Español
Brazier head	Tête plate	Flachrundkopf	Testa tonda	Cabeza alomada
Pin: Aluminium alloy* Polished	Tige: Alliage d'aluminium* Poli	Bolzen: Aluminium* Poliert	Bullone: Lega di alluminio* Lucido	Vástago: Aluminio* Pulido
Collar: Aluminium alloy* Natural	Bague: Alliage d'aluminium* Brut	Schließring: Aluminium* Blank	Collare: Lega di alluminio* Nessuna finitura	Collar: Aluminio* Natural

*: EN AW-7075, AlZn5.5MgCu **: EN AW-6061, AlMg1SiCu

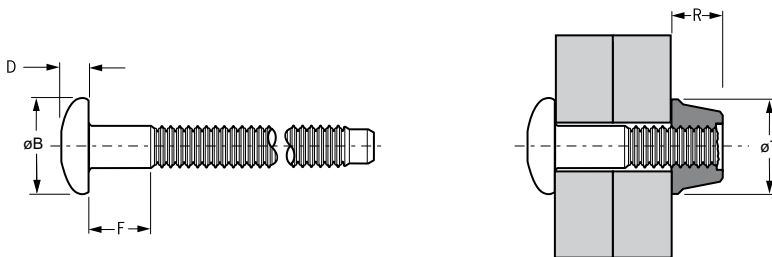

ø	Ø		ØB	D	F	R	øT	kN ¹⁾	kN ¹⁾	Part No/ref	Part No/ref	
	min.	max.										max.
4.8 (3/16")	1.6	15.9	5.16	10.0	3.4	2.3	7.9	9.9	4.23	5.78	01921-00610	01985-00600
	7.9	31.7									01921-00620	
6.4 (1/4")	1.6	15.9	6.75	13.3	4.2	2.2	11.1	13.0	7.45	9.79	01921-00810	01985-00800
	7.9	31.7									01921-00820	

all dimensions in mm / en millimètre / alle Maße in mm / in millimetri / en milímetros

1) typical values / valeurs moyennes / typische Werte / Valori tipici / resistencias máximas recomendadas

Avtainer® 2311



English	Français	Deutsch	Italiano	Español
Brazier head	Tête plate	Flachrundkopf	Testa tonda	Cabeza alomada
Pin: Low carbon steel* Zinc plated JS500 coated	Tige: Acier* Revêtement zingué Finition JS 500	Bolzen: Stahl* Verzinkt JS500 Beschichtung	Bullone: Acciaio a carbonio* Zincato Protezione JS500	Vástago: Acero al carbono* Zincado Pasivado JS500
Shell: Low carbon steel** Zinc plated Clear passivated	Bague: Acier bas carbone** Revêtement zingué Passivation claire	Hülse: Stahl** Verzinkt Klar chromatiert, Cr6-frei	Collare: Acciaio a basso tenore di carbonio** Zincato Passivazione chiara	Collar: Acero bajo en carbono** Zincado Pasivado claro
Locking slug: Nylon	Manchon: Nylon	Sicherungsbuchse: Nylon	Tubolare: Nylon	Junta de bloqueo: Nailon
Seal: Santoprene®	Joint: Santoprene®	Dichtscheibe: Santoprene®	Guarnizione: Santoprene®	Junta de estanqueidad: Santoprene®

*: BS 3111 Type 0 DIN 1654 Qst 34-3 **: BS 1449 CS 1 SAE 1008 DIN 1614 StW 24 / DIN 1624 St4

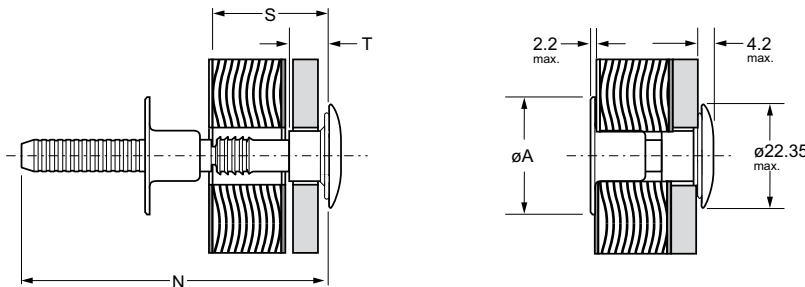

ø	e		S	N	T	Part No/ref	Collar / Bague / Hülse / Collare / Collar		kN ¹⁾	kN ¹⁾ e min.	kN ¹⁾ e max.
	nom.	min.					max.	øA			
10.0 (3/8")	12.70	15.87	14.3	56.9	-	02311-01209 ²⁾	32.0 22.9	02321-01200 ³⁾ 02325-01200 ⁴⁾	2.22	6.60	4.44
	14.27	17.45	15.9	56.9	-	02311-01210 ²⁾					
	15.87	19.05	17.5	58.4	4.6	02311-01211					
	17.45	20.62	19.0	60.2	6.1	02311-01212					
	19.05	22.22	20.6	61.7	7.9	02311-01213					
	20.62	23.80	22.2	63.2	9.4	02311-01214					
	22.22	25.40	23.8	64.8	10.9	02311-01215					
	23.80	26.97	25.4	66.5	12.5	02311-01216					
	25.40	28.57	27.0	75.9	14.2	02311-01217					
	26.97	30.15	28.6	75.9	14.2	02311-01218					
	28.57	31.75	30.2	75.9	14.2	02311-01219					
	30.15	33.32	31.7	75.9	14.2	02311-01220					
	31.75	34.92	33.3	75.9	14.2	02311-01221					
	33.32	36.50	34.9	75.9	14.2	02311-01222					
	34.93	38.10	36.5	75.9	14.2	02311-01223					
	36.50	39.67	38.1	75.9	14.2	02311-01224					

all dimensions in mm / en millimètre / alle Maße in mm / in millimetri / en milímetros

1) - 5) see page 47 / voir page 47 / siehe Seite 47 / vedi pagina 47 / ver Pág. 47

Avtainer® 2311

- 1) typical values / valeurs moyennes / typische Werte / Valori tipici / resistencias máximas recomendadas
- 2) Part numbers 01209 & 01210 do not have shouldered pins / Les références -1209 & -01210 ne possèdent pas d'épaulement / Artikel-Nr. 01209 & 01210 haben keine Stufe im Bolzenschaft / Codici prodotto 01209 & 01210 non hanno lo spallamento. / Las referencias 01209 y 01210 no tienen el cuerpo escalonado.
- 3) 02321-01200: The larger shell assembly is for use against softer material, spreading the bearing load. / La bague standard 02321-01200 est à utiliser sur des matériaux tendre, pour une meilleure répartition des efforts / Die größere Hülse ist für den Einsatz gegen weichere Materialien ausgelegt, die auftretende Kraft wird verteilt. / Collare di grande diametro per materiali teneri. / Collar de gran diámetro para materiales blandos.
- 4) 02325-01200: The smaller shell assembly should only be used against metal surfaces. / La bague à diamètre réduit ne peut être utilisée qu'en appui sur un support métallique. / Die kleinere Hülse darf nur auf Metalloberflächen eingesetzt werden. / Collare di piccolo diametro per superfici metalliche. / Collar de pequeño diámetro para superficies metálicas.
- 5) Where shells are used against metal surfaces, the hole through the metal should be 15 mm diameter or chamfered 2.5 mm x 45°. / Lorsque la bague prend appui sur un support métallique, percer à 15 mm de \varnothing ou chanfreiner l'entrée du trou à 45° x 2.5 / Bei Auflage der Hülse auf Metall ist im Metall eine 2,5 x 45°-Senkung oder ein Bohrungsdurchmesser von 15 mm erforderlich. / Quando i guschi sono usati su parti metalliche, il foro nella lamiera dovrebbe avere un diametro di 15mm o deve presentare una svasatura di 2,5mm a 45°. / Cuando el collar vaya sobre superficies metálicas, el taladro de la pieza metálica debe de ser de 15 mm o tener un avellanado de entrada de 2,5x45°.

Avbolt® 21001



English	Français	Deutsch	Italiano	Español	****
Stem: Chromium Molybdenum steel* Black oxide	Tige: Acier* Noir	Dorn: Stahl* Schwarz	Gambo: Acciaio* Passivato nero	Vástago: Acero* Pavonado	 8 h
Sleeve: Carbon steel** Zinc plated Clear trivalent passivated	Douille: Acier** Revêtement zingué Passivation claire trivalente	Hülse: Stahl** Verzinkt Klar chromatiert, Cr6-frei	Bussola: Acciaio** Zincata Passivazione chiara trivalente	Cuerpo: Acero al carbono** Zincado Pasivado claro trivalente	 240 h
Collar: Carbon steel*** Zinc plated Clear trivalent passivated	Bague: Acier*** Revêtement zingué Passivation claire trivalente	Schließring: Stahl*** Verzinkt Klar chromatiert, Cr6-frei	Collare: Acciaio*** Zincato Passivazione chiara trivalente	Collar: Acero al carbono*** Zincado Pasivado claro trivalente	 240 h

*: EN 10263-4 34CrMo4 SAE 4135 SCM435 **: EN 10263-2 C8C SAE 1008 ***: EN 10263-4 23MnB4
****: to red rust / à la rouille rouge / bis Rotrost / alla ruggine rossa / al óxido rojo (ASTM B117)

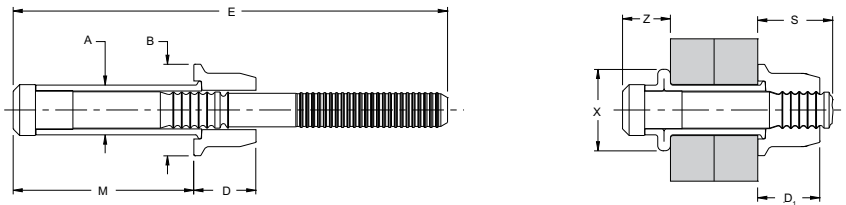

ø nom.					ø A max.	ø B max.	D max.	D ₁ max.	E min.	M max.	S max.	X nom.	Z max.			Part No/ref
	min.	max.	min.	max.												
10.0 (3/8")	4.78	7.95							73.78	25.10						21001-01204
	7.95	11.13							76.98	28.27						21001-01206
	11.13	14.30							80.18	31.45						21001-01208
	14.30	17.48							83.38	34.62						21001-01210
	17.48	20.65	10.49	11.05	10.47	18.77	12.65	14.51	86.58	37.80	18.34	15.5	9.58	45.00	32.25	21001-01212
	20.65	23.83							89.68	40.97						21001-01214
	23.83	27.00							92.88	44.15						21001-01216
	27.00	30.18							96.08	47.32						21001-01218
	30.18	33.35							99.28	50.50						21001-01220
12.7 (1/2")	6.38	9.55							80.57	31.82						21001-01604
	9.55	12.73							83.75	35.00						21001-01606
	12.73	15.90							86.93	38.18						21001-01608
	15.90	19.08							90.11	41.36						21001-01610
	19.08	22.25							93.28	44.53						21001-01612
	22.25	25.43	13.87	14.76	13.79	24.30	15.00	16.10	96.45	47.70	20.50	20.63	13.10	90.00	57.00	21001-01614
	25.43	28.60							99.62	50.87						21001-01616
	28.60	31.78							102.77	54.02						21001-01618
	31.78	34.95							105.91	57.16						21001-01620
	34.95	38.13							109.02	60.27						21001-01622
	38.13	41.30							112.10	63.35						21001-01624
16.0 (5/8")	6.35	12.70							102.71	39.35						21001-02004
	12.70	19.05							109.06	45.70						21001-02008
	19.05	25.40	17.45	18.49	17.30	29.47	17.45	20.07	115.41	52.05	30.48	25.4	16.01	129.00	91.19	21001-02012
	25.40	31.75							121.76	58.40						21001-02016
	31.75	38.10							128.11	64.75						21001-02020

all dimensions in mm / en millimètres / alle Maße in mm / in millimetri / en milímetros

Notes / Notes / Hinweise / Note / Notas

Avbolt® fasteners are supplied with lubricated collars and must not be degreased. / Avbolt® sont lubrifiées et ne doivent pas être dégraissées. / Avbolt® sind mit einem Gleitmittel beschichtet, welches nicht entfernt werden darf. / I Avbolt® sono forniti lubrificati e non devono essere sgrassati. / Los Avbolt® se suministran lubricados y no deben ser desengrasados.

Avbolt® 21021



English	Français	Deutsch	Italiano	Español	***
Body: Carbon steel* Zinc plated Clear trivalent passivated	Corps: Acier* Revêtement zingué Passivation claire trivalente	Hülse: Stahl* Verzinkt Klar chromatiert, Cr6-frei	Corpo: Acciaio* Zincata Passivazione chiara trivalente	Cuerpo: Acero al carbono* Zincado Pasivado claro trivalente	 240 h
Stem: Carbon steel** Black oxide	Tige: Acier** Noir	Dorn: Stahl** Schwarz brüniert	Gambo: Acciaio** Passivato nero	Vástago: Acero al car- bono** Pavonado	 8 h

*: SAE 1008 EN 10263-2 C8C **: SCM 435 SAE 4135 EN 10263-4 34CrMo4

***: to red rust / à la rouille rouge / bis Rotrost / alla ruggine rossa / al óxido rojo (ASTM B117)

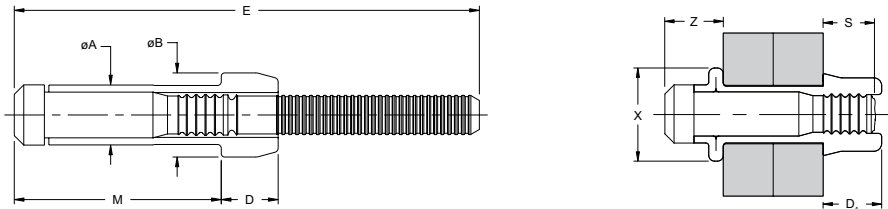

Ø nom.					ØA max.	ØB max.	D max.	D ₁ max.	E min.	M max.	S max.	X nom.	Z max.	 kN min.	 kN min.	Part No/ref
	min.	max.	min.	max.												
4.8 (3/16")	2.36	3.99	5.28	5.64	5.20	7.32	4.95	5.26	37.11	12.41	6.38	7.54	5.35	12.40	8.00	21021-00602
	3.99	5.59							38.69	14.01						21021-00603
	5.59	7.16							40.27	15.59						21021-00604
	7.16	8.76							41.84	17.19						21021-00605
	8.76	10.34							43.41	18.76						21021-00606
	10.34	11.94							44.99	20.36						21021-00607
	11.94	13.51							46.56	21.94						21021-00608
	13.51	15.11							48.14	23.54						21021-00609
	15.11	16.69							49.71	25.11						21021-00610
	16.69	18.29							51.29	26.71						21021-00611
	18.29	19.89							52.86	28.29						21021-00612
	6.4 (1/4")	2.36							3.99	7.04						7.42
3.99		5.59	47.32	18.11	21021-00803											
5.59		7.16	48.89	19.69	21021-00804											
7.16		8.76	50.47	21.29	21021-00805											
8.76		10.34	52.04	22.86	21021-00806											
10.34		11.94	53.62	24.46	21021-00807											
11.94		13.51	55.19	26.04	21021-00808											
13.51		15.11	56.77	27.64	21021-00809											
15.11		16.69	58.34	29.21	21021-00810											
16.69		18.29	59.92	30.81	21021-00811											
18.29		19.89	61.49	32.39	21021-00812											

all dimensions in mm / en millimètres / alle Maße in mm / in millimetri / en milímetros

Avbolt® 21021

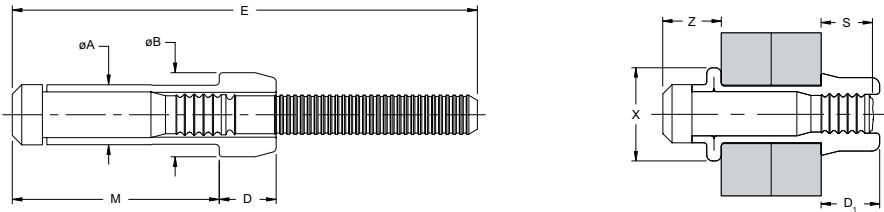

ø nom.	Ø		Ø		øA max.	øB max.	D max.	D ₁ max.	E min.	M max.	S max.	X nom.	Z max.	kN min.	kN min.	Part No/ref
	min.	max.	min.	max.												
8.0 (5/16")	4.78	7.95	8.84	9.35	8.76	12.39	8.61	9.20	62.42	23.31	10.25	12.28	9.10	36.47	23.57	21021-01004
	7.95	11.13							65.57	26.49						21021-01006
	11.13	14.30							68.72	29.66						21021-01008
	14.30	17.48							71.87	32.84						21021-01010
	17.48	20.65							75.02	36.01						21021-01012
	20.65	23.83							78.17	39.19						21021-01014
	23.83	26.97							81.32	42.36						21021-01016

all dimensions in mm / en millimètres / alle Maße in mm / in millimetri / en milímetros

Note / Note / Hinweis / Nota / Nota

Bodies are supplied lubricated and must not be degreased.

Les corps sont lubrifiés et ne doivent pas être dégraissés.

Hülsen sind mit einem Gleitmittel beschichtet, welches nicht entfernt werden darf.

I corpi sono forniti lubrificati e non devono essere sgrassati.

Los cuerpos se suministran lubricados y no deben ser desengrasados.

The Range of Avdel® Blind Fastening Systems



Speed Fastening® Systems

Extra fast and reliable fastening from one side.
Rivets are fed automatically.



Breakstem Systems

Blind fastening systems with various features from multi-grip capability to high strength stainless steel rivets.



Lockbolt Systems

High clamp force and vibration resistance for the highest strength joints.



Blind Threaded Inserts

Fast system for sustainable threads with high torque-to-turn.



Installation Equipment

From manually operated handtools to customised assembly workstations.