

生产现场、机床

A
B
C
D
E
F
G
H
I
J
K
L
M
N
O

用途索引

照片索引

型号索引

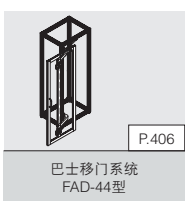
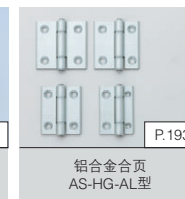
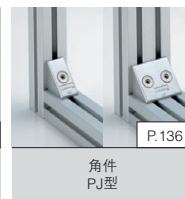
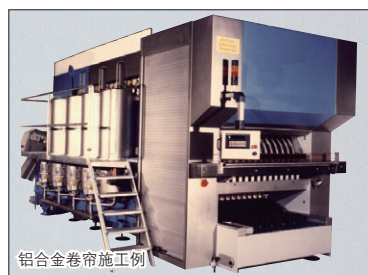
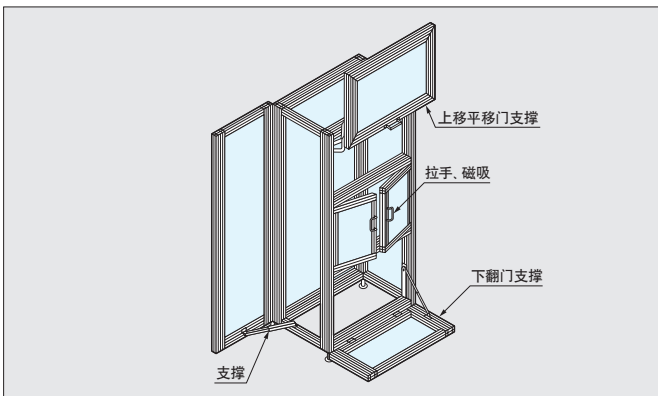
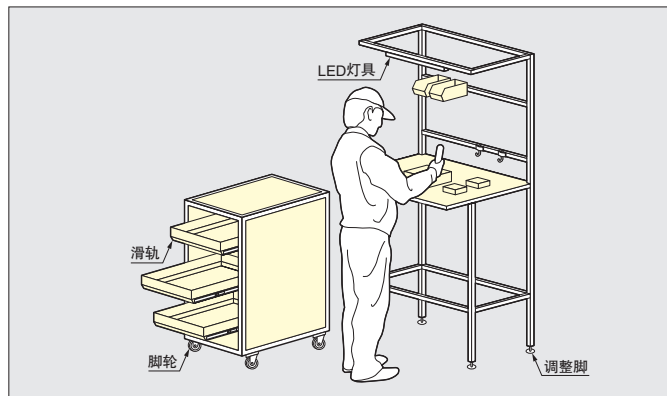
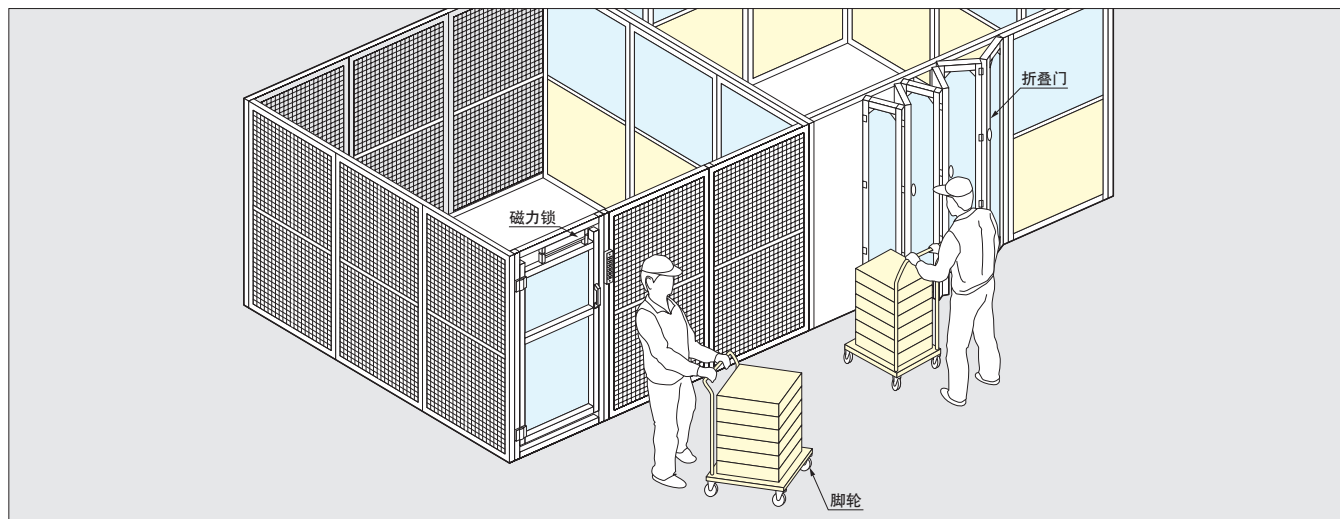

配电盘、分电盘、控制装置

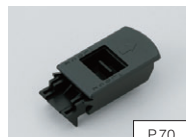
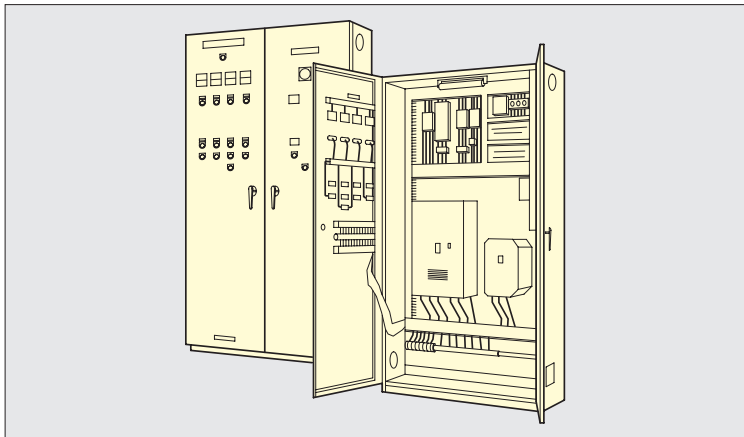
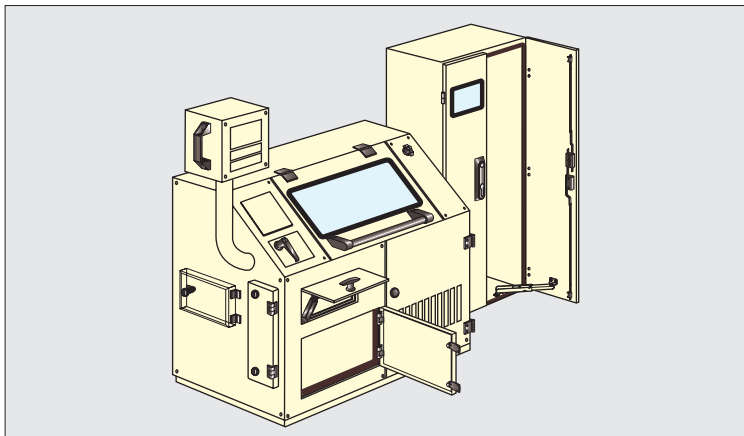

P.70

快装搭扣
SX-48
带临时固定功能



P.116

不锈钢扣件
STF100



P.120

不锈钢角扣
STF-A56AH平行安装型
STF-A56AC直角安装型



P.123

不锈钢锁扣(带弹簧)
PN-51



P.147

圆柱锁
SN-711-8型



P.170

笔记本电脑简易锁
WL-P1800型



P.172

箱锁
BL-70Y



P.174

TOT锁(磁铁钥匙)
外置门用



P.202

自闭式天地铰链
HG-PV60AC型

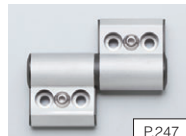

P.247

单向扭矩铰链
HG-TQA型

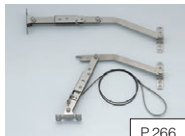

P.266

不锈钢带锁扣重型门用支
撑YA-2020型(无金属线)
YA-2020W型(带金属线)



P.270

底脚支撑
YF-200, YF-300,
YF-300-T50

半导体和液晶制造装置、无尘室

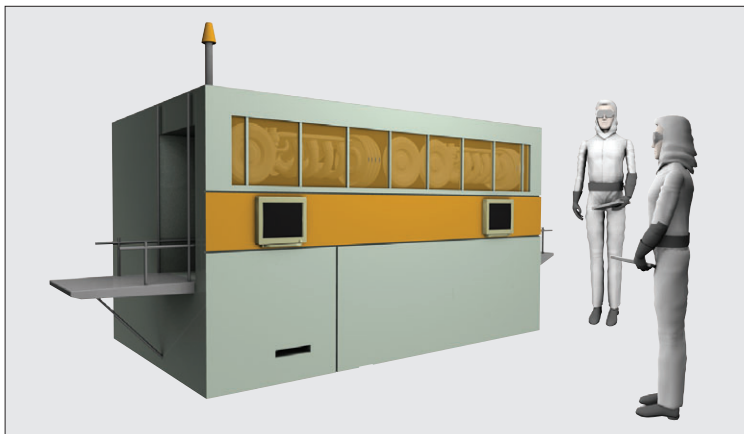

P.11

不锈钢(SUS316)拉手
MG型
符合SEMI标准



P.43

不锈钢嵌入式拉手
HH-KL160
符合SEMI标准



P.44

不锈钢嵌入式拉手
HH-KP150
符合SEMI标准

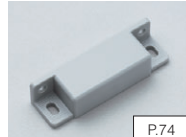

P.74

密封磁吸
MC-JM63G型



P.75

密封磁吸
MC-JM45



P.76

密封磁吸MC-JM50
无尘室用



P.115

不锈钢(SUS316)清洁扣件
STF-CV150型



P.189

清洁铰链
HG-CV-127型

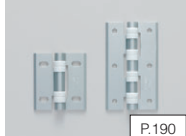

P.190

清洁铰链
HG-CV型

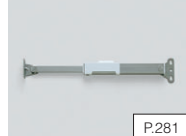

P.281

不锈钢清洁支撑
LB-CV215A



P.337

不锈钢三节滑轨
5302S
承重用



P.456

生物降解高性能润滑剂
Hypertepthro HPT
无尘室用

A
B
C
D
E
F
G
H
I
J
K
L
M
N
O

用途索引

照片索引

型号索引

信息终端设备 娱乐设备

A
B
C
D
E
F
G
H
I
J
K
L
M
N
O

用途索引

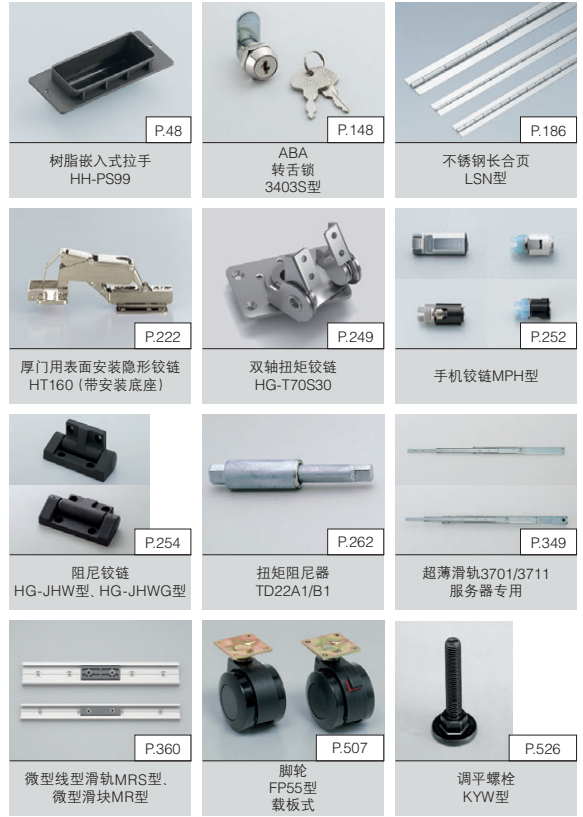

医疗设备

照片索引

型号索引

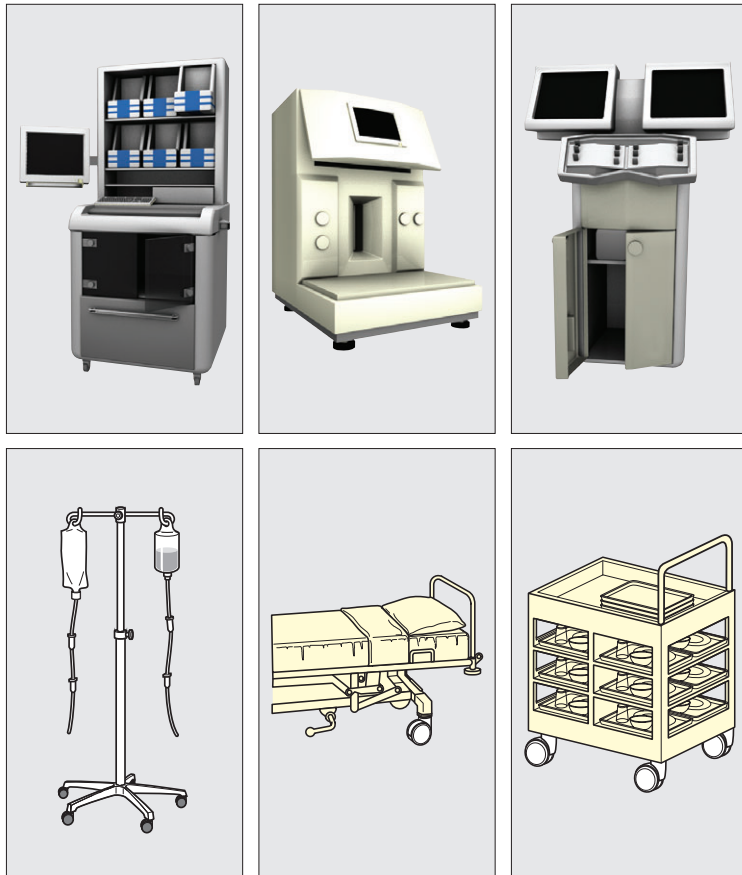

特装车、铁路设备

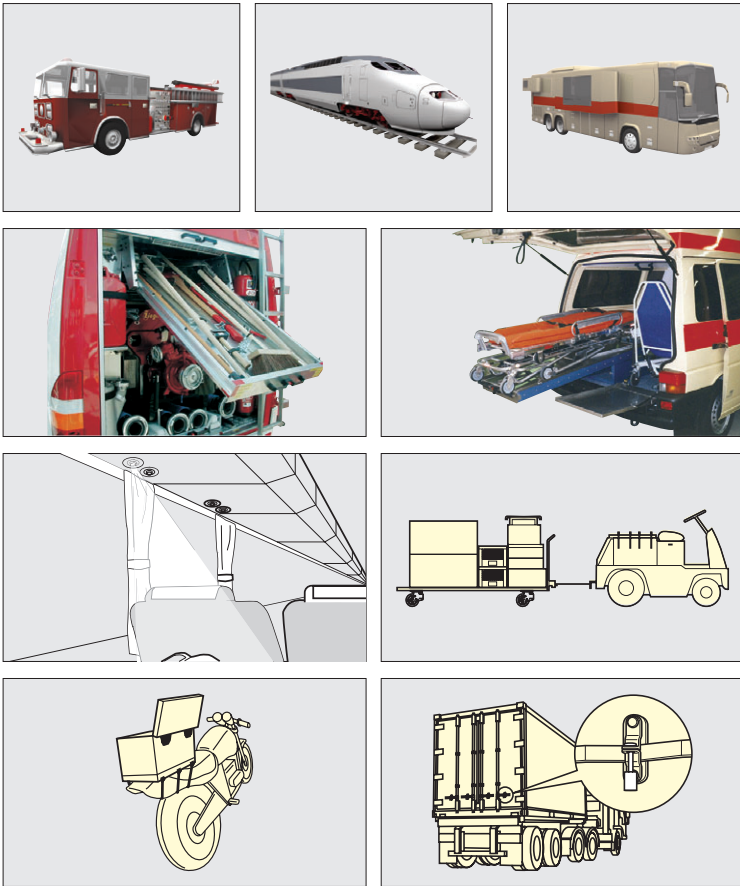

厨房设备、食品机械

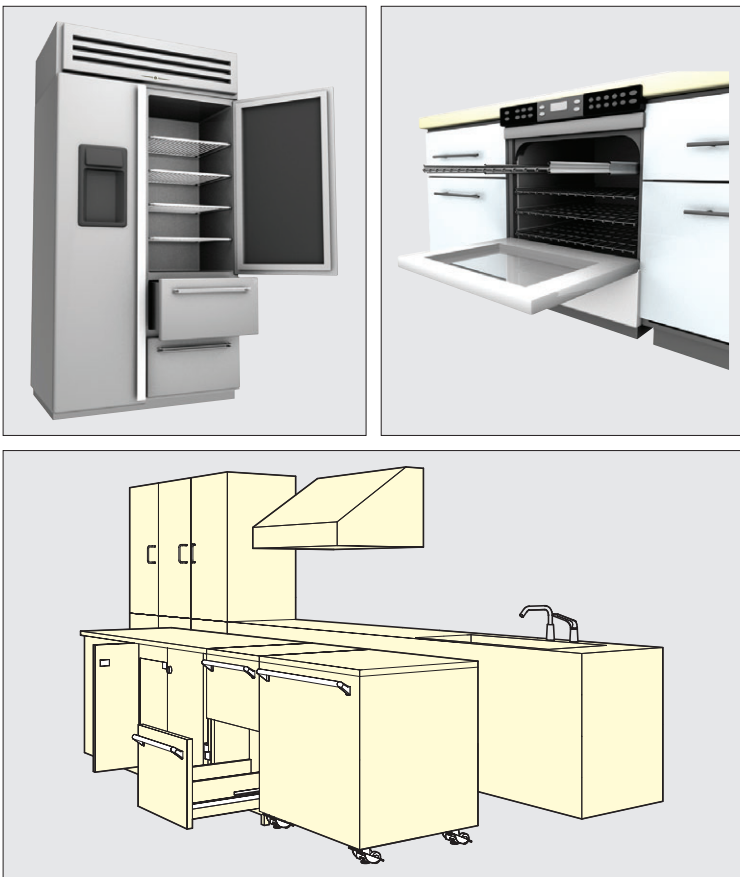

A
B
C
D
E
F
G
H
I
J
K
L
M
N
O

用途索引

照片索引

型号索引

在高温、高湿等苛刻条件下

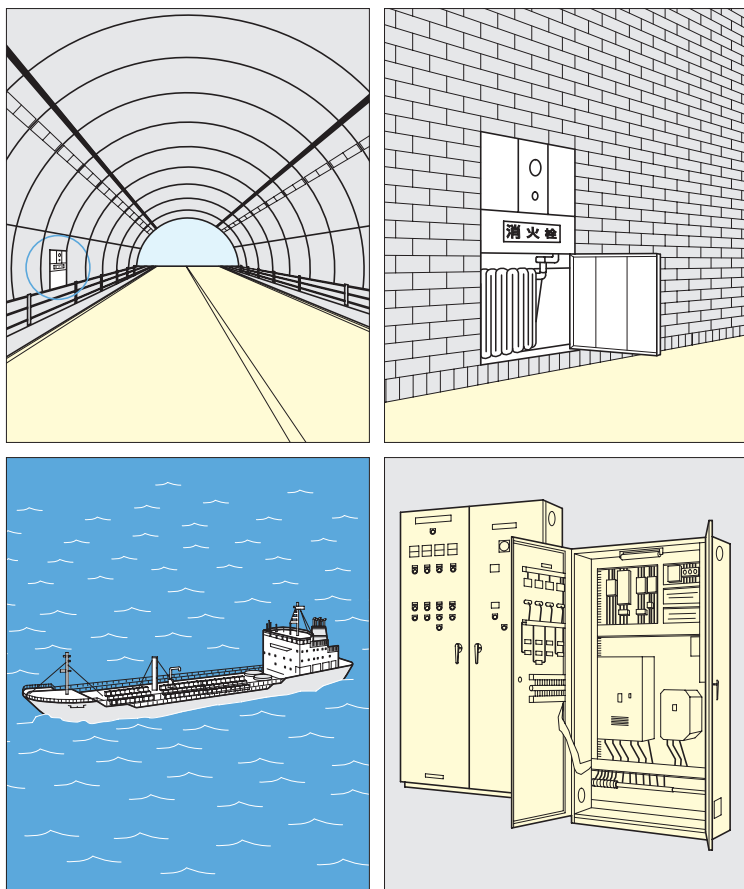

陈列、展示、仓储

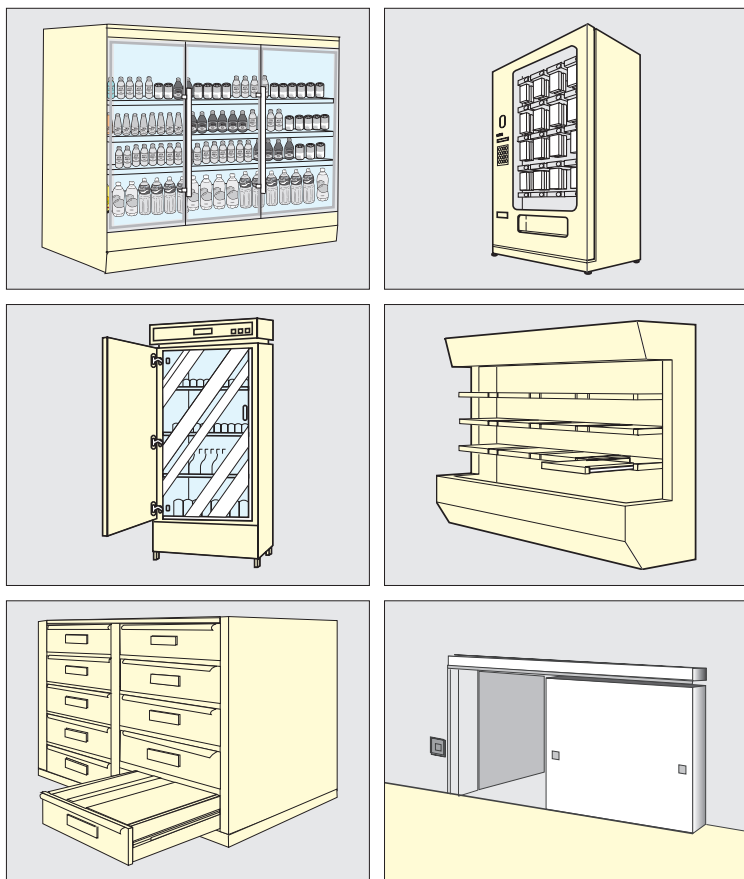

A
B
C
D
E
F
G
H
I
J
K
L
M
N
O

用途索引

照片索引

型号索引